

OPERATING INSTRUCTIONS

Personal Computer

Model No. **CF-D1** series

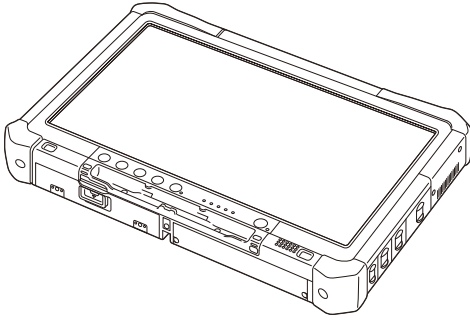

Contents

Getting Started

| | |
|-------------------------------------|----|
| Introduction..... | 2 |
| Read Me First..... (Precautions) | 3 |
| Description of Parts..... | 11 |
| First-time Operation..... | 14 |

Getting Started

Useful Information

| | |
|-------------------------------|----|
| On-screen Manual..... | 22 |
| Handling and Maintenance..... | 23 |
| Reinstalling Software..... | 25 |

Useful Information

Troubleshooting

| | |
|------------------------------|----|
| Troubleshooting (Basic)..... | 28 |
|------------------------------|----|

Troubleshooting

Appendix

| | |
|------------------------------------|----|
| LIMITED USE LICENSE AGREEMENT..... | 33 |
| Specifications..... | 34 |

Appendix

For further information about the computer, you can refer to the on-screen manual.

To access the on-screen manual
→ page 22 "On-screen Manual"

Introduction

Thank you for purchasing this Panasonic product. For optimum performance and safety, please read these instructions carefully.

■ Terms and illustrations in these instructions

CAUTION : Conditions that may result in minor or moderate injury.

NOTE : Useful and helpful information.

Windows 7

 (Start) - [All Programs] : Click  (Start), and then click [All Programs]. You may need to double-click in some cases.

Windows XP

[start] - [Run] : Click [start], and then click [Run]. You may need to double-click in some cases.

→ :

Page in these Operating Instructions or in the Reference Manual.



Reference to the on-screen manuals.

<Only when using software keyboard>

Enter : Click [Enter] key.

Ctrl + C : Click [Ctrl] key, and then click [C] key.

<Only when using an external keyboard>

Enter : Press [Enter] key.

Ctrl + C : Press and hold [Ctrl] key, and then press [C] key.

- The display of the key may be different from this manual according to the keyboard used. (e.g. "Delete" instead of "Del")

- **Windows 7** indicates Genuine Windows® 7 Professional Operating System.
- **Windows XP** indicates Genuine Microsoft® Windows® XP Professional Operating System.
- Some illustrations are simplified to help your understanding and may look different from the actual unit.
- If you do not log on as an administrator, you cannot use some functions or cannot display some screens.
- Refer for the latest information about optional products to the catalogs, etc.
- In these instructions, the names and terms are referred as follows.
 - "Genuine Windows® 7 Professional 32-bit Service Pack 1" and "Genuine Windows® 7 Professional 64-bit Service Pack 1" as "Windows" or "Windows 7"
 - "Genuine Microsoft® Windows® XP Professional Service Pack 3" as "Windows", "Windows XP" or "Windows XP Professional"
 - Circular media including DVD-ROM and CD-ROM as "discs"

■ Disclaimer

Computer specifications and manuals are subject to change without notice. Panasonic Corporation assumes no liability for damage incurred directly or indirectly from errors, omissions or discrepancies between the computer and the manuals.

■ Trademarks

Microsoft®, Windows®, the Windows logo, and IntelliMouse are registered trademarks of Microsoft Corporation of the United States and/or other countries.

Intel, Core, Centrino and PROSet are either registered trademarks or trademarks of Intel Corporation.

SDXC Logo is a trademark of SD-3C, LLC.



Adobe, the Adobe logo and Adobe Reader are either registered trademarks or trademarks of Adobe Systems Incorporated in the United States and/or other countries.

Bluetooth™ is a trademark owned by Bluetooth SIG, Inc., U.S.A. and licensed to Panasonic Corporation.

Names of products, brands, etc., appearing in this manual are trademarks or registered trademarks of their respective own companies.

Read Me First

Information to the User

<Only for model with wireless LAN>

This product and your Health

This product, like other radio devices, emits radio frequency electromagnetic energy. The level of energy emitted by this product however is far much less than the electromagnetic energy emitted by wireless devices like for example mobile phones.

Because this product operates within the guidelines found in radio frequency safety standards and recommendations, we believe this product is safe for use by consumers. These standards and recommendations reflect the consensus of the scientific community and result from deliberations of panels and committees of scientists who continually review and interpret the extensive research literature.

In some situations or environments, the use of this product may be restricted by the proprietor of the building or responsible representatives of the organization. These situations may for example include:

- Using this product on board of airplanes, or
- In any other environment where the risk of interference to other devices or services is perceived or identified as harmful.

If you are uncertain of the policy that applies on the use of wireless devices in a specific organization or environment (e.g. airports), you are encouraged to ask for authorization to use this product prior to turning on the product.

Regulatory Information

We are not responsible for any radio or television interference caused by unauthorized modification of this product. The correction of interference caused by such unauthorized modification will be the responsibility of the user. We and its authorized resellers or distributors are not liable for damage or violation of government regulations that may arise from failing to comply with these guidelines.

26-M-1

For Used in Motor Vehicle /Pour L'utilisation Dans Un Véhicule Motorisé

Warning: Notebook Computer may be installed in a motor vehicle and visible to the driver only if used to support vehicle related functions such as vehicle information, system control, rear or side observation and navigation.

If used for entertainment purpose, such as television reception or video play, it must be installed to the rear of the driver's seat where it will not be visible, directly or indirectly, to the operator of the motor vehicle. Check with individual state/provincial laws to determine lawful use of this product while operating within a motor vehicle.

Avertissement : L'ordinateur bloc-notes peut être installé dans un véhicule motorisé et dans le champ de vision du conducteur uniquement en tant que dispositif d'aide aux fonctions du véhicule, comme par exemple pour fournir des informations sur le véhicule, comme dispositif de contrôle de système, pour l'observation à l'arrière ou sur les côtés du véhicule, ainsi que pour fournir de l'information routière.

Pour toute utilisation à fin de divertissement, comme par exemple pour regarder la télévision ou jouer à des jeux vidéo, il doit être installé à l'arrière du siège du conducteur, en un emplacement où il ne sera pas visible, ni directement ni indirectement, pour le conducteur du véhicule motorisé. Vérifiez les lois fédérales et nationales

qui régissent l'utilisation légale de cet appareil à l'intérieur d'un véhicule motorisé.

35-M-1

Lithium Battery / Pile au lithium

Lithium Battery!

This computer contains a lithium battery to enable the date, time, and other data to be stored. The battery should only be exchanged by authorized service personnel.

Warning! A risk of explosion from incorrect installation or misapplication may possibly occur.

15-E-1

Pile au lithium!

Le micro-ordinateur renferme une pile au lithium qui permet de sauvegarder certaines données, notamment la date et l'heure. La pile ne doit être remplacée que par un technicien qualifié.

Danger ! Risque d'explosion en cas de non respect de cette mise en garde!

15-F-1

Information for Users on Collection and Disposal of Old Equipment and used Batteries



These symbols on the products, packaging, and/or accompanying documents mean that used electrical and electronic products and batteries should not be mixed with general household waste.

For proper treatment, recovery and recycling of old products and used batteries, please take them to applicable collection points, in accordance with your national legislation and the Directives 2002/96/EC and 2006/66/EC.

By disposing of these products and batteries correctly, you will help to save valuable resources and prevent any potential negative effects on human health and the environment which could otherwise arise from inappropriate waste handling.

For more information about collection and recycling of old products and batteries, please contact your local municipality, your waste disposal service or the point of sale where you purchased the items.

Penalties may be applicable for incorrect disposal of this waste, in accordance with national legislation.

For business users in the European Union

If you wish to discard electrical and electronic equipment, please contact your dealer or supplier for further information.



[Information on Disposal in other Countries outside the European Union]

These symbols are only valid in the European Union. If you wish to discard this product, please contact your local authorities or dealer and ask for the correct method of disposal.



Note for the battery symbol (bottom two symbol examples):

This symbol might be used in combination with a chemical symbol. In this case it complies with the requirement set by the Directive for the chemical involved.

53-E-1

Safety Precautions

<Only for model with wireless WAN>

The following safety precautions must be observed during all phases of the operation, usage, service or repair of any Personal Computer or Handheld Computer incorporating wireless WAN modem. Manufacturers of the cellular terminal are advised to convey the following safety information to users and operating personnel and to incorporate these guidelines into all manuals supplied with the product. Failure to comply with these precautions violates safety standards of design, manufacture and intended use of the product. Panasonic assumes no liability for customer failure to comply with these precautions.



When in a hospital or other health care facility, observe the restrictions on the use of mobiles. Switch Personal Computer or Handheld Computer incorporating wireless WAN modem off, if instructed to do so by the guidelines posted in sensitive areas. Medical equipment may be sensitive to RF energy.

The operation of cardiac pacemakers, other implanted medical equipment and hearing aids can be affected by interference from Personal Computer or Handheld Computer incorporating wireless WAN modem placed close to the device. If in doubt about potential danger, contact the physician or the manufacturer of the device to verify that the equipment is properly shielded. Pacemaker patients are advised to keep their Personal Computer or Handheld Computer incorporating wireless WAN modem away from the pacemaker, while it is on.



Switch off Personal Computer or Handheld Computer incorporating wireless WAN modem before boarding an aircraft. Make sure it cannot be switched on inadvertently. The operation of wireless appliances in an aircraft is forbidden to prevent interference with communications systems. Failure to observe these instructions may lead to the suspension or denial of cellular services to the offender, legal action, or both.

For details on usage of this unit in aircrafts please consult and follow instruction provided by the airline.



Do not operate Personal Computer or Handheld Computer incorporating wireless WAN modem in the presence of flammable gases or fumes. Switch off the cellular terminal when you are near petrol stations, fuel depots, chemical plants or where blasting operations are in progress. Operation of any electrical equipment in potentially explosive atmospheres can constitute a safety hazard.



Your Personal Computer or Handheld Computer incorporating wireless WAN modem receives and transmits radio frequency energy while switched on. Remember that interference can occur if it is used close to TV sets, radios, computers or inadequately shielded equipment. Follow any special regulations and always switch off Personal Computer or Handheld Computer incorporating wireless WAN modem wherever forbidden, or when you suspect that it may cause interference or danger.



Road safety comes first! Do not use a Personal Computer or Handheld Computer incorporating wireless WAN modem while driving a vehicle. Do not place the computer with wireless WAN modem in an area where it could cause personal injury to the driver or passengers. It is recommended to stow the unit in the boot or secure stowage area while driving. Do not place the computer with wireless WAN modem in an area over an air bag or in the vicinity where an air bag may deploy. Air bags inflate with great force and if the computer with wireless WAN modem is placed in the air bag deployment area may be propelled with great force and cause serious injury to occupants of the vehicle.



IMPORTANT!

Personal Computer or Handheld Computer incorporating wireless WAN modem operate using radio signals and cellular networks cannot be guaranteed to connect in all conditions. Therefore, you should never rely solely upon any wireless device for essential communications, for example emergency calls.

Remember, in order to make or receive calls, Personal Computer or Handheld Computer incorporating wireless WAN modem must be switched on and in a coverage area with adequate cellular signal strength.

Some networks do not allow for emergency calls if certain network services or phone features are in use (e.g. lock functions, fixed dialing etc.). You may need to deactivate those features before you can make an emergency call.

Some networks require that a valid SIM card be properly inserted in Personal Computer or Handheld Computer incorporating wireless WAN modem.

Models for U.S.A.

Federal Communications Commission Radio Frequency Interference Statement

Note: This equipment has been tested and found to comply with the limits for a Class B digital device, pursuant to Part 15 of the FCC Rules. These limits are designed to provide reasonable protection against harmful interference in a residential installation. This equipment generates, uses and can radiate radio frequency energy and, if not installed and used in accordance with the instructions, may cause harmful interference to radio communications. However, there is no guarantee that interference will not occur in a particular installation. If this equipment does cause harmful interference to radio or television reception, which can be determined by turning the equipment off and on, the user is encouraged to try to correct the interference by one or more of the following measures:

- Reorient or relocate the receiving antenna.
- Increase the separation between the equipment and receiver.
- Connect the equipment into an outlet on a circuit different from that to which the receiver is connected.
- Consult the Panasonic Service Center or an experienced radio/TV technician for help.

Warning

To assure continued compliance, use only shielded interface cables when connecting to a computer or peripheral. Also, any changes or modifications not expressly approved by the party responsible for compliance could void the user's authority to operate this equipment.

This device complies with Part 15 of the FCC Rules.

Operation is subject to the following two conditions:

- (1) This device may not cause harmful interference, and
- (2) This device must accept any interference received, including interference that may cause undesired operation.

- This equipment is provided with PC Card slot that could be used with wireless transmitters, which will be specifically recommended when they become available.

Other third-party wireless transmitters have not been RF exposure evaluated for use with this computer and may not comply with FCC RF exposure requirements.

<Only for model with wireless LAN/Bluetooth>

- This equipment complies with FCC radiation exposure limits set forth for an uncontrolled environment.
- This equipment has been approved for portable operation, and does not require any minimum spacing be provided between antennas and all person's body.
- This equipment may not be co-located or operated with any other antenna or transmitter.

25-M-4

<Optional Car Mounter / Port Replicator>

- This equipment is provided with external antenna connector(s) for connection to optional Car Mounter or Port Replicator for mobile external mounted antenna(s). External antenna(s) must be professionally installed and cannot exceed recommended maximum antenna gain as described in individual provided supplement instructions for wireless transmitters. For WLAN, the Car Mounter should be used with Radiall/ Larsen WLAN whip antenna, type

NMO5E2400BKTNC with 5 dBi antenna gain or less. Also, user must maintain minimum 20 cm spacing between external antenna(s) and all person's body (excluding extremities of hands, wrist and feet) during wireless modes of operation.

25-M-1

<Only for model with wireless LAN>

This product is restricted to indoor use due to its operation in the 5.15 to 5.25 GHz frequency range. FCC requires this product to be used indoors for the frequency range 5.15 to 5.25 GHz to reduce the potential for harmful interference to co-channel Mobile Satellite systems. High power radars are allocated as primary users of the 5.25 to 5.35 GHz and 5.65 to 5.85 GHz bands. These radar stations can cause interference with and/or damage this product.

25-M-W-1

Responsible Party: Panasonic Corporation of North America
One Panasonic Way
Secaucus, NJ 07094
Tel No:1-800-LAPTOP5 (1-800-527-8675)

6-M-1

FCC RF Exposure Warning:

This equipment is provided with external antenna connector(s) for connection to optional Car Mounter or Port Replicator for mobile external mounted antenna(s). External antenna(s) must be professionally installed and cannot exceed recommended maximum antenna gain as described in individual provided supplement instructions for wireless transmitters. The Car Mounter is provided with Radiall/Larsen WLAN whip antenna, type NMO5E2400BKTNC with 5 dBi antenna gain. The maximum allowable antenna gain for the external WWAN base whip antenna for the cellular band is 7.1 dBi and PCS band is 2.5 dBi. Also, user must maintain minimum 20 cm spacing between external antenna(s) and all person's body (excluding extremities of hands, wrist and feet) during wireless modes of operation.

32-M-1

USA Only: Disposal may be regulated in your community due to environmental considerations. For disposal or recycling information, please visit Panasonic web site: <http://www.panasonic.com/environmental> or call 1-888-769-0149

65-M-2

Models for Canada

Canadian ICES-003

This Class B digital apparatus complies with Canadian ICES-003.

Cet appareil numérique de la classe B est conforme à la norme NMB-003 du Canada.

7-M-2

<Only for model with wireless LAN/Bluetooth/GPS>

Industry Canada

This product complies with RSS210 Industry Canada. Operation is subject to the following two conditions; (1) this device may not cause interference, and (2) this device must accept any interference, including interference that may cause undesired operation of the device.

<Ne s'applique qu'aux modèles avec technologie Bluetooth/LAN sans fil/WAN sans fil>

Industrie Canada

Cet équipement est conforme à la norme CNR-210 d'In-

Read Me First

dustrie Canada. Son fonctionnement est soumis aux deux conditions suivantes :

- (1) ce dispositif ne peut produire de brouillage, et
- (2) ce dispositif doit accepter le brouillage, y compris le brouillage pouvant entraîner le fonctionnement non désiré de l'appareil.

30-Ca-1-1

<Only for model with wireless LAN>

This product (local network devices) for the band 5150-5250 MHz is only for indoor usage to reduce potential for harmful interference to co-channel Mobile Satellite systems.

High power radars are allocated as primary users (meaning they have priority) of 5250-5350 MHz and 5650-5850 MHz and these radars could cause interference and/or damage to LELAN devices.

<Ne s'applique qu'aux modèles avec technologie LAN sans fil>

Cet appareil (pour réseaux locaux radioélectriques) dans les bandes de fréquences 5150-5250 MHz est réservé à une utilisation à l'intérieur afin de réduire le risque d'interférence avec les systèmes satellites mobiles bicanaux. Les radars forte puissance sont désignés comme étant les premiers utilisateurs (c'est-à-dire qu'ils ont la priorité) des bandes de fréquences 5250-5350 MHz et 5650-5850 MHz. Ces stations radars peuvent provoquer des interférences et/ou des dommages à ce périphérique.

30-Ca-2-1

<Only for model with wireless LAN>

This device has been designed to operate with the Radiall/Larsen whip antenna, type NMO5E2400BKTNC WLAN antenna having a maximum gain of 5 dBi. A WLAN Antenna having a higher gain is strictly prohibited per regulations of Industry Canada. The Required antenna impedance is 50 ohms.

To reduce potential radio interference to other users, the antenna type and its gain should be so chosen that the equivalent isotropically radiated power (EIRP) is not more than that required for successful communication.

<Ne s'applique qu'aux modèles avec technologie LAN sans fil>

Cet appareil est conçu pour opérer avec l'antenne-fouet Radiall/Larsen, type WLAN NMO5E2400BKTNC, ayant un gain maximum de 5 dB. Les règlements d'Industrie Canada interdisent l'utilisation d'une antenne WLAN dont le gain serait supérieur à cette limite. L'antenne doit avoir une impédance de 50 ohms.

Afin de réduire le risque d'interférence radioélectrique aux autres utilisateurs des bandes de fréquences, le type d'antenne et son gain doivent être tels que la puissance isotrope rayonnée équivalente (PIRE) n'est pas plus élevée que le niveau requis pour assurer la communication.

25-Ca-1-1

<Only for model with wireless LAN/wireless WAN/Bluetooth>

* This computer complies with Industry Canada radiation exposure limits set forth for an uncontrolled environment.

* This PC with WLAN and/or Bluetooth transmitters installed, has been approved for portable operation and does not require any minimum spacing be provided between antennas and all person's body.

<Ne s'applique qu'aux modèles avec technologie Bluetooth/LAN sans fil/WAN sans fil>

* Cet équipement est conforme aux limites d'exposition aux rayonnements d'Industrie Canada établies pour un environnement non contrôlé.

* Ce PC avec émetteurs WLAN et/ou Bluetooth a été approuvé à des fins d'opération mobile; aucun espace minimum entre les antennes et le corps de l'utilisateur n'est requis.

This device has been designed to operate with the WWAN antenna having a maximum gain of 7.1 dB for the cellular band and 2.5 dB for the PCS band. WWAN Antenna having a higher gain is strictly prohibited per regulations of Industry Canada. The Required antenna impedance is 50 ohms.

To reduce potential radio interference to other users, the antenna type and its gain should be so chosen that the equivalent isotropically radiated power (EIRP) is not more than that required for successful communication.

<Utilisation au Canada>

Cet appareil est conçu pour opérer avec une antenne WWAN (réseau étendu sans fil) dont le gain maximum est fixé à 7.1 dB pour la bande cellulaire et à 2,5 dB pour la bande de service de communications personnelles (PCS). Les règlements d'Industrie Canada interdisent l'utilisation d'une antenne WWAN dont le gain serait supérieur à cette limite. L'antenne doit avoir une impédance de 50 ohms.

Afin de réduire le risque d'interférence radioélectrique aux autres utilisateurs des bandes de fréquences, le type d'antenne et son gain doivent être tels que la puissance isotrope rayonnée équivalente (PIRE) n'est pas plus élevée que le niveau requis pour assurer la communication.

32-Ca-1-1

FOR USE WITH MODEL NO. : CF-AA5713A
POUR UTILISER AVEC MODÈLE : CF-AA5713A

20-Ca-1

Models for Europe

<Only for model with a "CE" mark on the bottom of the computer>

CE Declaration of Conformity (DoC)
"Hereby, Panasonic declares that this Personal Computer is in compliance with the essential requirements and other relevant provisions of the Directive 1999/5/EC."

Hint:

If you want to get a copy of the original DoC of our above mentioned products, please contact our web address:
<http://www.doc.panasonic.de>

Authorised Representative:
Panasonic Testing Centre
Panasonic Marketing Europe GmbH
Winsbergring 15, 22525 Hamburg, Germany

Indication of the countries where WLAN is intended to be used:
AT BE BG CH CY CZ DE DK EE ES
FI FR GB GR HU IE IS IT LT LU
LV MT NL NO PL PT RO SE SI SK TR

18-25-E-0

<Only for model with a “CE” mark on the bottom of the computer>



Declaration of Conformity (DoC)

“Hereby, Panasonic declares that this Personal Computer is in compliance with the essential requirements and other relevant provisions of EU Council Directives.”

Authorised Representative:
Panasonic Testing Centre
Panasonic Marketing Europe GmbH
Winsbergring 15, 22525 Hamburg, Germany

18-E-0

Regulations for Wireless LAN/Bluetooth

| Country / Region | 802.11a | 802.11b/g Bluetooth |
|--|--|---|
| Austria, Belgium, Croatia, Cyprus, Czech Republic, Denmark, Estonia, Finland, Germany, Greece, Hungary, Iceland, Ireland, Latvia, Lithuania, Macedonia, Malta, Netherlands, Poland, Portugal, Slovakia, Slovenia, Spain, Sweden, Switzerland, United Kingdom | Restricted to indoor use. | |
| France | Restricted to indoor use. | Restricted to indoor use. |
| Italy | Restricted to indoor use. General authorization required if used outside. | General authorization required if used outside of own premises. |
| Luxembourg | Restricted to indoor use. General authorization required for public service. | General authorization required for public service. |
| Turkey | Restricted to indoor use. Prohibited within an 1 km radius from the centre of the runway of the airports. | |
| Norway | Restricted to indoor use. | Prohibited within a 20 km radius from the centre of Ny-Ålesund. |

- The latest version of “ERC RECOMMENDATION 70-03” by European Radiocommunications Committee and the regulation in Turkey.
- Use only the antenna specified by Panasonic.
- Confirm the latest information to the radio regulation authorities.

40-E-1

For Used in Motor Vehicle

Warning: Check the following Commission Recommendation to determine proper installation and usage of this product while operating within a motor vehicle.
“Commission Recommendation on safe and efficient in-vehicle information and communication systems: A

European statement of principles on human machine interface.”

Commission Recommendation is available from Official Journal of the European Communities.

35-E-1

When using Port Replicator or Car Mounter on which an external antenna can be installed:

- External antenna for wireless LAN must be professionally installed.
- The gain of external antenna for wireless LAN must not exceed 5 dBi.
- The user must maintain minimum of 20 cm spacing between the external antenna and all people (excluding extremities of hands, wrist and feet) during wireless modes of operation.

41-E-1-1

This equipment requires minimum 20 cm spacing from all person’s body (excluding extremities of hands, wrist and feet) in directions of the back and both sides of the LCD display during wireless modes of operation.

60-E-1

Models for UK

Warning

This apparatus must be earthed for your safety.

To ensure safe operation the three-pin plug must be inserted only into a standard three-pin power point which is effectively earthed through the normal household wiring. Extension cords used with the equipment must be three-core and be correctly wired to provide connection to earth. Wrongly wired extension cords are a major cause of fatalities.

The fact that the equipment operates satisfactorily does not imply that the power point is earthed and that the installation is completely safe.

For your safety, if you have any doubt about the effective earthing of the power point, consult a qualified electrician.

FOR YOUR SAFETY PLEASE READ THE FOLLOWING TEXT CAREFULLY

This appliance is supplied with a moulded three pin mains plug for your safety and convenience.

A 3 amp fuse is fitted in this plug.

Should the fuse need to be replaced please ensure that the replacement fuse has a rating of 3 amps and that it is approved by ASTA or BSI to BS 1362.

Check for the ASTA mark or the BSI mark on the body of the fuse.

If the plug contains a removable fuse cover you must ensure that it is refitted when the fuse is replaced.

If you lose the fuse cover the plug must not be used until a replacement cover is obtained.

A replacement fuse cover can be purchased from your local Panasonic Dealer.

IF THE FITTED MOULDED PLUG IS UNSUITABLE FOR THE SOCKET OUTLET IN YOUR HOME THEN THE FUSE SHOULD BE REMOVED AND THE PLUG CUT OFF AND DISPOSED OF SAFELY.

THERE IS A DANGER OF SEVERE ELECTRICAL SHOCK IF THE CUT OFF PLUG IS INSERTED INTO ANY 13 AMP SOCKET.

If a new plug is to be fitted please observe the wiring code as shown below.

If in any doubt please consult a qualified electrician.

Read Me First

Warning: THIS APPLIANCE MUST BE EARTHED. Important

The wires in this mains lead are coloured in accordance with the following code:

| | |
|-------------------|---------|
| Green-and-yellow: | Earth |
| Blue: | Neutral |
| Brown: | Live |

As the colours of the wires in the mains lead of this apparatus may not correspond with the coloured markings identifying the terminals in your plug, proceed as follows: The wire which is coloured GREEN-and-YELLOW must be connected to the terminal in the plug which is marked by the letter E or by the safety earth symbol \oplus coloured GREEN or GREEN-and-YELLOW.

The wire which is coloured Blue must be connected to the terminal which is marked with the letter N or coloured BLACK.

The wire which is coloured Brown must be connected to the terminal which is marked with the letter L or coloured RED. The mains plug on this equipment must be used to disconnect the mains power.

Please ensure that a socket outlet is available near the equipment and shall be easily accessible.

■ How to replace the fuse

Open the fuse compartment with a screwdriver and replace the fuse.

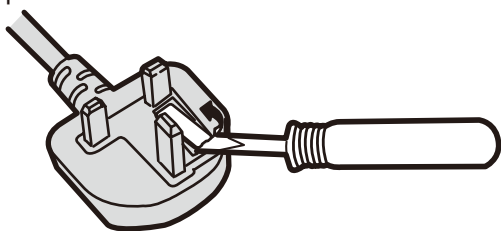

Warnings

- This equipment is not designed for connection to an IT power system. (An IT system is a system having no direct connections between live parts and Earth; the exposed-conductive-parts of the electrical installation are earthed. An IT system is not permitted where the computer is directly connected to public supply systems in the U.K.)
- Disconnect the mains plug from the supply socket when the computer is not in use.

This equipment is produced to BS800/1983.

8-E-1

Precautions

THIS PRODUCT IS NOT INTENDED FOR USE AS, OR AS PART OF, NUCLEAR EQUIPMENT/SYSTEMS, AIR TRAFFIC CONTROL EQUIPMENT/SYSTEMS, AIRCRAFT COCKPIT EQUIPMENT/SYSTEMS ¹, MEDICAL DEVICES OR ACCESSORIES ², LIFE SUPPORT SYSTEMS OR OTHER EQUIPMENTS/DEVICES/SYSTEMS THAT ARE INVOLVED WITH ENSURING HUMAN LIFE OR SAFETY. PANASONIC WILL NOT BE RESPONSIBLE FOR ANY LIABILITY RESULTING FROM THE USE OF THIS PRODUCT ARISING OUT OF THE FOREGOING USES.

¹ AIRCRAFT COCKPIT EQUIPMENT/SYSTEMS include Class2 Electrical Flight Bag (EFB) Systems and Class1 EFB Systems when used during critical phases of flight (e.g., during take-off and landing) and/or mounted on to the aircraft. Class1 EFB Systems and 2 EFB Systems are defined by FAA: AC (Advisory Circular) 120-76A or JAA: JAA TGL (Temporary Guidance Leaflets) No.36.

² As defined by the European Medical Device Directive (MDD) 93/42/EEC.

Panasonic cannot guarantee any specifications, technologies, reliability, safety (e.g. Flammability/Smoke/Toxicity/Radio Frequency Emission, etc) requirements related to aviation standards and medical equipment standards that differ from the specifications of our COTS (Commercial-Off-The-Shelf) products.

This computer is not intended for use in medical equipment including life-support systems, air traffic control systems, or other equipment, devices or systems that are involved with ensuring human life or safety. Panasonic cannot be held responsible in any way for any damages or loss resulting from the use of this unit in these types of equipment, devices or systems, etc.

This product was developed based on thorough research into the real-world portable computing environments. Exhaustive pursuit of usability and reliability under harsh conditions led to innovations such as the magnesium alloy exterior, vibration damped hard disk drive and floppy disk drive, flexible internal connections. This product's outstanding engineering has been tested using the strict MIL-STD-810F (for vibration and shock) and IP (for dust and water) based procedures.

As with any portable computer device precautions should be taken to avoid any damage. The following usage and handling procedures are recommended.

Before putting the computer away, be sure to wipe off any moisture.

If a Malfunction or Trouble Occurs, Immediately Stop Use

If a Malfunction Occurs, Immediately Unplug the AC Plug and the Battery Pack

- This product is damaged
- Foreign object inside this product
- Smoke emitted
- Unusual smell emitted
- Unusually hot

Continuing to use this product while any of the above conditions are present may result in fire or electric shock.

- If a malfunction or trouble occurs, immediately turn the power off and unplug the AC plug, and then remove the battery pack. Then contact your technical support office for repair.

Do Not Touch This Product and Cable When It Starts Thundering

Electric shock may result.

Do Not Connect the AC Adaptor to a Power Source Other Than a Standard Household AC Outlet

Otherwise, a fire due to overheating may result. Connecting to a DC/AC converter (inverter) may damage the AC adaptor. On an airplane, only connect the AC adaptor/charger to an AC outlet specifically approved for such use.

Do Not Do Anything That May Damage the AC Cord, the AC Plug, or the AC Adaptor

Do not damage or modify the cord, place it near hot tools, bend, twist, or pull it forcefully, place heavy objects on it, or bundle it tightly.

Continuing to use a damaged cord may result in fire, short circuit, or electric shock.

Do Not Pull or Insert the AC Plug If Your Hands Are Wet

Electric shock may result.

Clean Dust and Other Debris of the AC Plug Regularly

If dust or other debris accumulates on the plug, humidity, etc. may cause a defect in the insulation, which may result in a fire.

- Pull the plug, and wipe it with a dry cloth.

Pull the plug if the computer is not being used for a long period of time.

Insert the AC Plug Completely

If the plug is not inserted completely, fire due to overheating or electric shock may result.

- Do not use a damaged plug or loose AC outlet.

Do Not Place Containers of Liquid or Metal Objects on Top of This Product

If water or other liquid spills, or if paper clips, coins, or foreign matter get inside this product, fire or electric shock may result.

- If foreign matter has found its way inside, immediately turn the power off and unplug the AC plug and remove the battery pack. Then contact your technical support office.

Close the Connector Cover Tightly When Using This Product Where Is a Lot of Water, Moisture, Steam, Dust, Oily Vapors, etc.

The entry of foreign matter may cause a fire or electric shocks.

- If foreign matter has found its way inside, immediately turn the power off and unplug the AC cord, and then remove the battery pack. Then contact your technical support office.

Do Not Disassemble This Product

You may receive an electric shock, or foreign matter may enter and result in a fire.

Keep SD Memory Cards Away from Infants and Small Children

Accidental swallowing will result in bodily injury.

- In the event of accidental swallowing, see a doctor immediately.

Do Not Place This Product on Unstable Surfaces

If balance is lost, this product may fall over or drop, resulting in an injury.

Avoid Stacking

If balance is lost, this product may fall over or drop, resulting in an injury.

Do Not Block the Ventilation Hole (Exhaust)

Using this product wrapped in cloth or on top of bedding or a blanket can block the ventilation hole and cause heat to build up inside, possibly resulting in a fire.

Hold the Plug When Unplugging the AC Plug

Pulling on the cord may damage the cord, resulting in a fire or electric shock.

Do Not Move This Product While the AC Plug Is Connected

The AC cord may be damaged, resulting in fire or electric shock.

- If the AC cord is damaged, unplug the AC plug immediately.

Use Only the Specified AC Adaptor With This Product
Using an AC adaptor other than the one supplied (supplied with the unit or one sold separately as an accessory) may result in a fire.

Do Not Subject the AC Adaptor to Any Strong Impact

Using the AC adaptor after a strong impact such as being dropped may result in electric shock, short circuit, or fire.

Take a Break of 10-15 Minutes Every Hour

Using this product for long periods of time may have detrimental health effects on the eyes or hands.

Do Not Connect a Telephone Line, or a Network Cable Other Than the One Specified, into the LAN Port

If the LAN port is connected to a network such as the ones listed below, a fire or electric shock may result.

- Networks other than 100BASE-T, 100BASE-TX or 10BASE-T
- Phone lines (IP phone (Internet Protocol Telephone), Telephone lines, internal phone lines (on-premise switches), digital public phones, etc.)

Do Not Use With Exposing the Skin to This Product For a Long Period of Time

Using this product with exposing the skin to the heat source of this product or AC adaptor for a long period of time can cause a low-temperature burn.

Do Not Expose Yourself to the Hot Wind from the Ventilation Hole (Exhaust) For a Long Period of Time

Low-temperature burns may result.

Covering the ventilation hole (exhaust) with your hand or other object can cause heat to build up inside, possibly resulting in burns.

Do Not Expose the Skin To This Product When Using the Product In A Hot Or Cold Environment

Burns, low-temperature burns, or frostbite may result.

- When it is necessary to expose the skin to this product such as to scan a fingerprint, perform the operation in the shortest time possible.

Do Not Turn the Volume Up Too Loud When Using Headphones

Listening at high volumes that overstimulate the ear for long periods of time may result in loss of hearing.

- Do not place the computer near a television or radio receiver.
- Keep the computer away from magnets. Data stored on the hard disk may be lost.
- This computer is not intended for the display of images for use in medical diagnosis.
- This computer is not intended for a use with connection of medical equipment for the purpose of medical diagnosis.
- Panasonic shall not be liable for loss of data or other incidental or consequential damages resulting from the use of this product.

Interface Cable

Use of an interface cable longer than 3 m {9.84 feet} is not recommended.

11-E-1

Precautions (Battery Pack)

Do Not Use With Any Other Product

The battery pack is rechargeable and was intended for the specified product. If it is used with a product other than the one for which it was designed, electrolyte leakage, generation of heat, ignition or rupture may result.

Read Me First

Do Not Charge the Battery Using Methods Other Than Those Specified

If the battery is not charged using one of the specified methods, electrolyte leakage, generation of heat, ignition or rupture may result.

Do Not Throw the Battery Pack into a Fire or Expose It to Excessive Heat

Generation of heat, ignition or rupture may result.

Avoid Extreme Heat (Near the Fire, in Direct Sunlight, for Example)

Electrolyte leakage, generation of heat, ignition or rupture may result.

Do Not Insert Sharp Objects into the Battery Pack, Expose It to Bumps or Shocks, Disassemble, or Modify It

Electrolyte leakage, generation of heat, ignition or rupture may result.

- If this product is subjected to a strong impact, stop using it immediately.

Do Not Short the Positive (+) and Negative (-) Contacts

Generation of heat, ignition or rupture may result.

- Do not place the battery pack together with articles such as necklaces or hairpins when carrying or storing.

Do Not Use This Product With a Battery Pack Other Than the One Specified

Use only the specified battery pack (→ page 11) with your product. Use of battery packs other than those manufactured and supplied by Panasonic may present a safety hazard (generation of heat, ignition or rupture).

When battery pack has deteriorated, replace it with a new one

Continued use of a damaged battery pack may result in heat generation, ignition or battery rupture.

CAUTION:

Risk of Explosion if Battery is replaced by an Incorrect Type. Dispose of Used Batteries According to the Instructions.

58-E-1

ATTENTION:

Il y a risque d'explosion si la batterie est remplacée par une batterie de type incorrect.
Mettre au rebut les batteries usagées conformément aux instructions.



58-F-1

- Do not touch the terminals on the battery pack. The battery pack may no longer function properly if the contacts are dirty or damaged.
- Do not expose the battery pack to water, or allow it to become wet.
- If the battery pack will not be used for a long period of time (a month or more), charge or discharge (use) the battery pack until the remaining battery level becomes 30% to 40% and store it in a cool, dry place.
- This computer prevents overcharging of the battery by recharging only when the remaining power is less than approx. 95% of capacity.
- The battery pack is not charged when the computer is first purchased. Be sure to charge it before using it for the first time. When the AC adaptor is connected to the computer, charging begins automatically.
- Should the battery leak and the fluid get into your eyes, do not rub your eyes. Immediately flush your eyes with clear water and see a doctor for medical treatment as soon as possible.

NOTE

- The battery pack may become warm during recharg-

ing or normal use. This is completely normal.

- Recharging will not commence if internal temperature of the battery pack is outside of the allowable temperature range (0 °C to 50 °C) (→  Reference Manual "Battery Power"). Once the allowable range requirement is satisfied, charging begins automatically. Note that the recharging time varies based on the usage conditions. (Recharging takes longer than usual when the temperature is 10 °C or below.)
- If the temperature is low, the operating time is shortened. Only use the computer within the allowable temperature range.
- This computer has a high temperature mode function that prevents the degradation of the battery in high temperature environments. (→  Reference Manual "Battery Power") A level corresponding to a 100% charge for high temperature mode is approximately equivalent to an 80% charge level for normal temperature mode.
- The battery pack is a consumable item. If the amount of time the computer can be run by using a particular battery pack becomes dramatically shorter and repeated recharging does not restore its performance, the battery pack should be replaced with a new one.
- When transporting a spare battery inside a package, briefcase, etc., it is recommended that it be placed in a plastic bag so that its contacts are protected.
- Always power off the computer when it is not in use. Leaving the computer on when the AC adaptor is not connected will exhaust the remaining battery capacity (→  Reference Manual "LAN").



A lithium ion battery that is recyclable powers the product you have purchased.

Please call 1-800-8-BATTERY for information on how to recycle this battery.

L'appareil que vous vous êtes procuré est alimenté par une batterie au lithium-ion.

Pour des renseignements sur le recyclage de la batterie, veuillez composer le 1-800-8-BATTERY.

48-M-1

Description of Parts

Front side

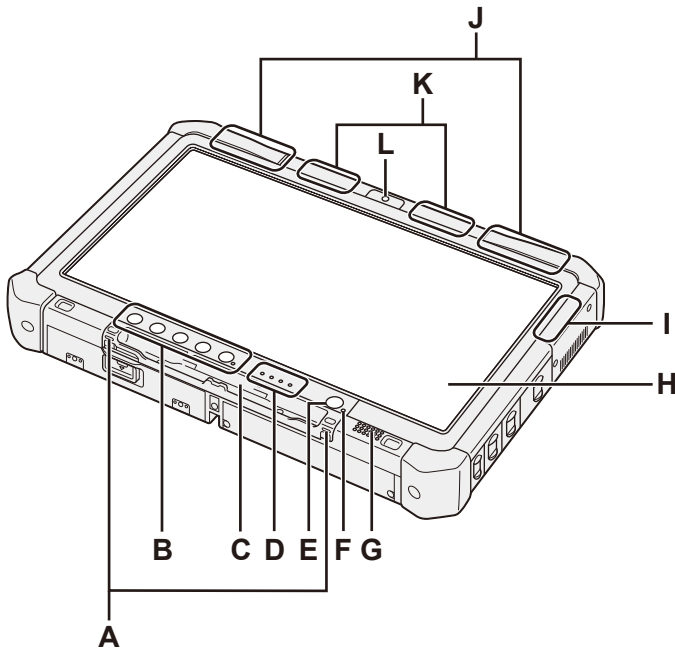

A: Tether Hooks

The tether hooks are not provided for some models.

B: Tablet Buttons

→ Reference Manual "Tablet Buttons"

C: Pen Holder

D: LED Indicator

: Battery status

→ Reference Manual "Battery Power"

: Wireless ready

This indicator lights when wireless LAN, Bluetooth, and/or Wireless WAN are connected and ready. It does not necessarily indicate the On/Off condition of the wireless connection.

→ Reference Manual "Wireless LAN", "Bluetooth", "Wireless WAN", "Disabling/Enabling Wireless Communication"

: Hard disk drive status

: SD Memory Card Indicator (Blinking: During access)

→ Reference Manual "SD Memory Card"

E: Power Switch

F: Power Status

(Off: Power off/Hibernation, Green: Power on, Blinking green: Sleep (**Windows 7**) / Standby (**Windows XP**), Blinking green rapidly: Cannot power on or resume due to low temperature.)

G: Speaker

→ Reference Manual "Dashboard for Panasonic PC"

H: LCD

→ Reference Manual "Touchscreen"

I: Bluetooth Antenna

<Only for model with Bluetooth>

→ Reference Manual "Bluetooth"

Bottom and rear side

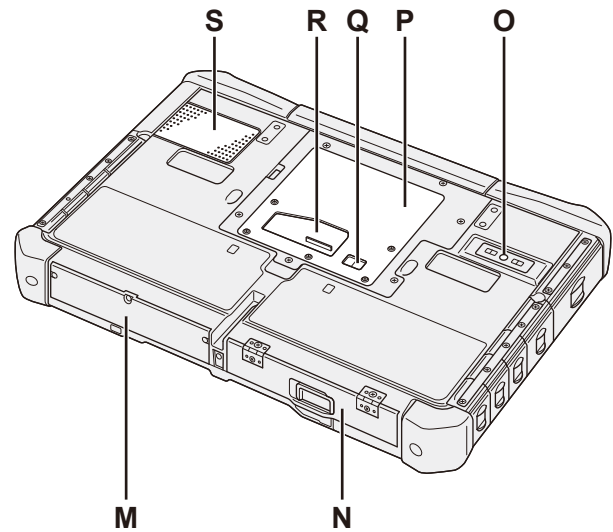

J: Wireless WAN Antenna

<Only for model with wireless WAN>

→ Reference Manual "Wireless WAN"

K: Wireless LAN Antenna

<Only for model with wireless LAN>

→ Reference Manual "Wireless LAN"

L: Front Camera

<Only for model with front camera>

→ Reference Manual "Camera"

M: Hard Disk Drive

N: Battery Pack

Specified Battery pack: CF-VZSU73U

O: Rear Camera

<Only for model with rear camera>

→ Reference Manual "Camera"

P: RAM Module Slot

→ Reference Manual "RAM Module"

Q: External Antenna Connector

R: Expansion Bus Connector

→ Reference Manual "Cradle"

S: Ventilation Hole (Intake)

Description of Parts

Right side

Parts (F) illustrated below are all optional.

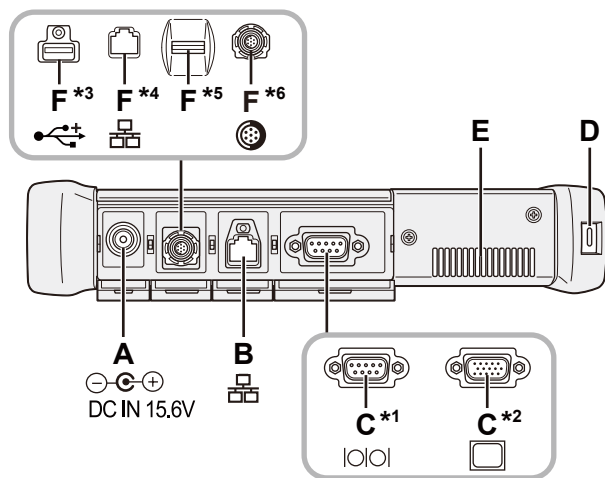

Left side

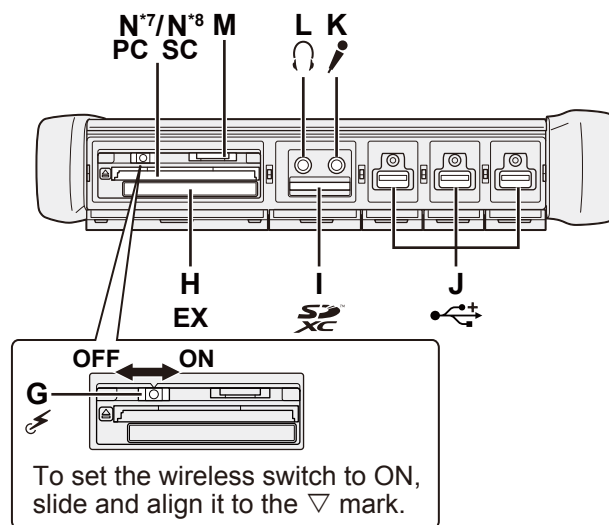

A: DC-IN Jack

B: LAN Port

→ *Reference Manual* "LAN"

C: Serial Port¹ / VGA Port²

¹ <Only for model with serial port>

² <Only for model with VGA port>

→ *Reference Manual* "External Display"

D: Security Lock

A Kensington cable can be connected. For further information, read the manual that comes with the cable.

E: Ventilation Hole (Exhaust)

F: 4th USB2.0 Port³ / 2nd LAN Port⁴ / Fingerprint Reader⁵ / Rugged USB2.0 Port⁶

³ <Only for model with 4th USB2.0 port>

→ *Reference Manual* "USB Devices"

⁴ <Only for model with 2nd LAN port>

→ *Reference Manual* "LAN"

⁵ <Only for model with Fingerprint reader>

→ *Reference Manual* "Fingerprint Reader"

⁶ <Only for model with rugged USB2.0 port>

→ *Reference Manual* "USB Devices"

G: Wireless Switch

→ *Reference Manual* "Disabling / Enabling Wireless Communication"

H: ExpressCard Slot

→ *Reference Manual* "PC Card / ExpressCard"

I: SD Memory Card Slot

→ *Reference Manual* "SD Memory Card"

J: USB2.0 Ports

→ *Reference Manual* "USB Devices"

K: Microphone Jack

A condenser microphone can be used. If other types of microphones are used, audio input may not be possible, or malfunctions may occur as a result.

L: Headphone Jack

You can connect headphones or amplified speakers. When they are connected, audio from the internal speakers is not heard.

M: SIM Card Slot

<Only for model with wireless WAN>

Insert the SIM card into the SIM card slot with the contact side facing downward and with the cut corner oriented forward.

→ *Reference Manual* "Wireless WAN"

N: PC Card Slot⁷ / Smart Card Slot⁸

⁷ <Only for model with PC Card slot>

→ *Reference Manual* "PC Card / ExpressCard"

⁸ <Only for model with Smart Card slot>

→ *Reference Manual* "Smart Card"

- This computer contains a magnet and magnetic products at the location circled in the illustration at right. Avoid leaving metallic object or magnetic media in contact with this area.

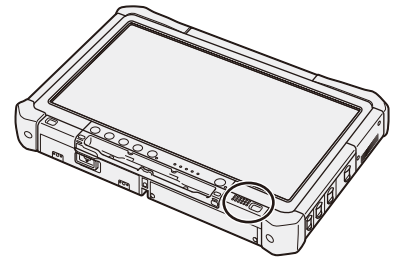

First-time Operation

■ Preparation

① Check and identify the supplied accessories.

If you do not find the described accessories, contact Panasonic Technical Support.

- AC Adaptor 1
- AC Cord 1
- Battery Pack 1

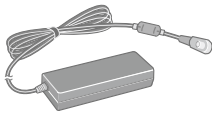

Model No: CF-AA5713A

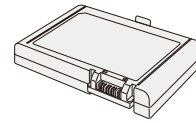

Model No: CF-VZSU73U

- Soft Cloth 1



- Stylus 1

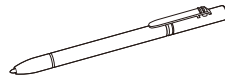

Model No: CF-VNP017DU
Some models may be supplied with a stylus different from the above.

- Tether 1

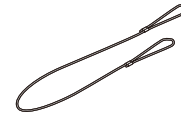

Model No: CF-VNT004DU
Some models may not be supplied with a tether, or supplied with a tether different from the above.

(→ Reference Manual "Touchscreen")

- Safety Precautions and Regulatory Information 1
- Depending on the model, the following items are supplied.
 - OPERATING INSTRUCTIONS (CD-ROM) 1
 - Product Recovery DVD-ROM Windows® 7 Professional SP1 1 set

② Read the LIMITED USE LICENSE AGREEMENT before breaking the seal on the computer's packaging (→ page 33).

■ Inserting the Battery Pack

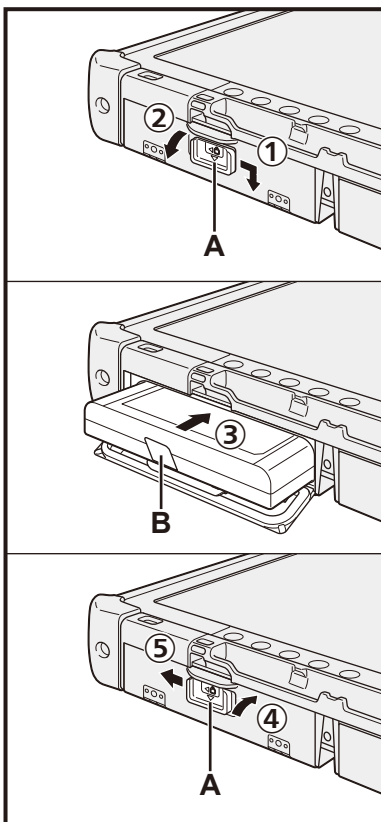

- ① Slide the latch (A) in the direction of the arrow.
- ② Open the cover.
- ③ Insert the battery pack until it securely fits the connector.
- ④ Close the cover until it clicks.
- ⑤ Slide the latch (A) in the direction of the arrow.

■ To remove the battery pack

In step ③ above, pull the tab (B) of the battery pack.

CAUTION

- Make sure the latch is securely locked. Otherwise the battery pack may fall when you carry the computer.

NOTE

- Note that the computer consumes electricity even when the computer power is off. If the battery pack is fully charged, the battery will fully discharge in the following period of time:
 - When power is off: Approx. 9 weeks
 - In sleep (**Windows 7**)/standby (**Windows XP**): Approx. 4 days
 - In hibernation: Approx. 8 days
 If "Wake Up from LAN" is disabled, the period of time in sleep will become slightly longer, and the period of time in hibernation will become about the same as during power-off.
- When the DC plug is not connected to the computer, disconnect the AC cord from your AC wall outlet. Power is consumed simply by having the AC adaptor plugged into an electrical outlet.

■ Attaching the stylus to the computer <Only for model with tether>

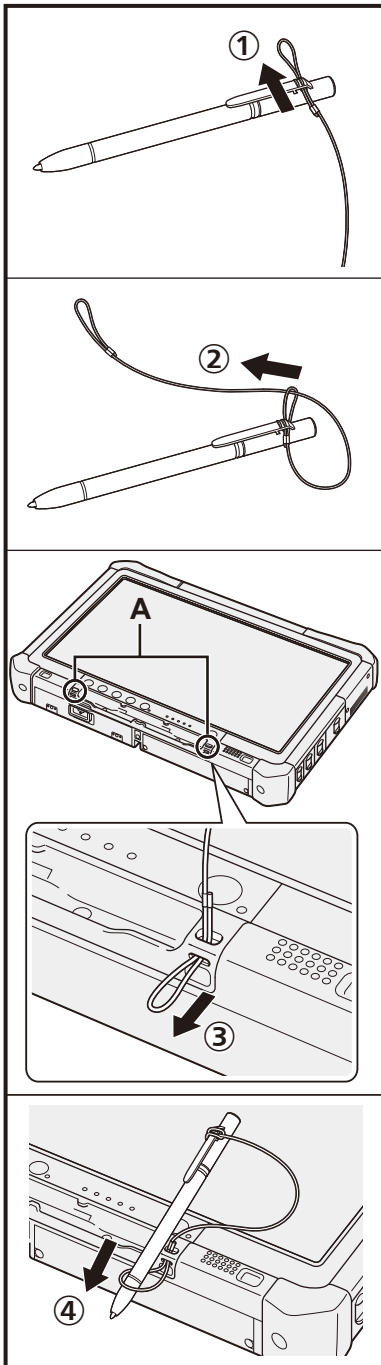

Use the tether to attach the stylus to the computer so you will not lose it. There are holes (A) to attach it.

- ① Pass one of the loops through the hole.
- ② Pass the second loop on the tether through the first one.
- ③ Thread the second loop through the hole (A).
- ④ Pass the stylus through the second loop.

First-time Operation

1 Inserting the Battery Pack (→ page 14)

- Do not touch the terminals of the battery pack and the computer. Doing so can make the terminals dirty or damaged, and may cause malfunction of the battery pack and the computer.
- Be sure to attach the cover for use.

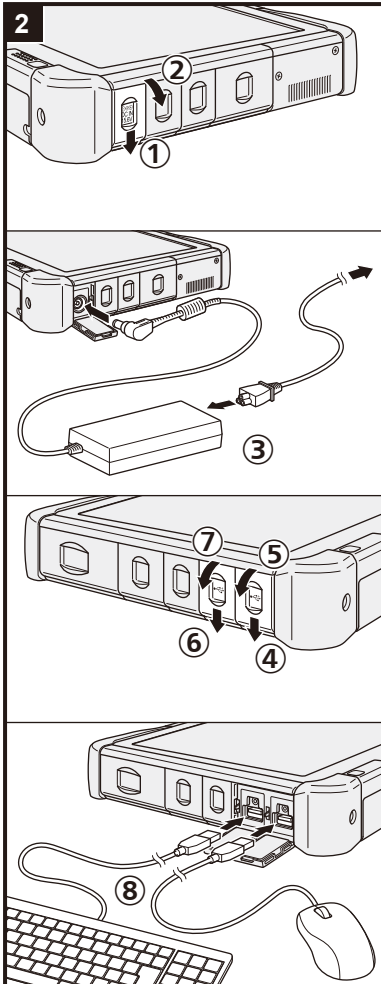

2 Connect your computer to a power outlet, and connect the external keyboard and mouse to the USB ports.

- ① Slide the latch in the direction of the arrow.
- ② Open the cover.
- ③ Connect the AC adaptor.
The battery charging starts automatically.
- ④ Slide the latch of one of the three USB ports in the direction of the arrow.
- ⑤ Open the cover.
- ⑥ Slide the latch of another USB port in the direction of the arrow.
- ⑦ Open the cover.
- ⑧ Connect the external keyboard and mouse to the USB ports.

CAUTION

- Do not disconnect the AC adaptor and do not switch the wireless switch to on until the first-time operation procedure is completed.
- When using the computer for the first time, do not connect any peripheral device except the battery pack, AC adaptor, external keyboard and mouse.
- **Handling the AC adaptor**
 - Problems such as sudden voltage drops may arise during periods of thunder and lightning. Since this could adversely affect your computer, an uninterruptible power source (UPS) is highly recommended unless running from the battery pack alone.

3 Turn on the computer.

- ① Confirm the wireless switch (→ page 12) is OFF.
- ② Press and hold the power switch (⏻) until the power indicator (A) lights.

CAUTION

- Do not press the power switch repeatedly.
- The computer will forcibly be turned off if you press and hold the power switch for 4 seconds or longer.
- Once you turn off the computer, wait for 10 seconds or more before you turn on the computer again.
- Do not perform the following operation until the hard disk drive indicator (HDD) turns off.
 - Connecting or disconnecting the AC adaptor
 - Pressing the power switch
 - Touching the touchscreen, external keyboard or external mouse
 - Turn on/off the wireless switch
- When the CPU temperature is high, the computer may not start up to prevent overheating of the CPU. Wait until the computer cools down, and then turn the power on again. If the computer does not power on even after cooling down, contact Panasonic Technical Support.
- Any changes from the default setting of the Setup Utility must not be made until the First-time Operation is completed.

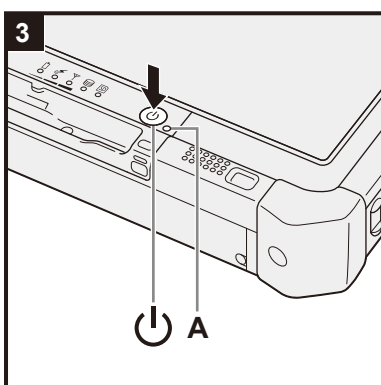

Windows 7

4 <For MUI OS model> Select language and OS (32 bit or 64 bit).

NOTE

- You can operate with the Tablet Buttons. Follow the instructions displayed on the screen.
 - ① Select language and OS (32bit or 64bit) on “Select OS” screen and click [OK].

The language setting will start by clicking [OK] on the confirmation screen. You can return to the “Select OS” screen by clicking [Cancel].
The language and OS setting will be completed in about 15 minutes.
 - ② When termination screen is displayed, click [OK] to turn off the computer.
 - ③ Turn on the computer.

CAUTION

- Carefully choose your language because you cannot change it later. If you set a wrong language, you need to reinstall Windows.

5 Setup Windows.

Follow the on-screen instructions.

- The computer restarts several times. Do not touch the touchscreen, external keyboard or external mouse, and wait until the hard disk drive indicator  has turned off.

Windows 7

- After the computer is turned on, the screen remains black or unchanged for a while. This is not a malfunction. Wait for a moment until the Windows setup screen appears.
- During setup of Windows, use the touchscreen, external mouse, external keyboard and clicking to move the cursor and to click an item.
- Setup of Windows will take approximately 20 minutes.
Go to the next step, confirming each message on the display.
- “Join a wireless network” screen may not appear.
You can set the Wireless Network after the setup of Windows is complete.

Windows XP

- Setup of Windows will take approximately 20 minutes. Go to the next step, confirming each message on the display.

<For MUI OS model>

- For some languages, the characters on the key and inputted character may not match. Set the keyboard properly after the setup is complete. Then set the password.
- Do not change the settings on the screen where you select a country or region. You can set a country, region or keyboard layout in [Clock, Language, and Region] of [Control Panel] after the Windows setup is complete.

CAUTION

- Wait until the hard disk drive indicator  has turned off.
- You can change the user name, password, image and Wireless Networks (**Windows 7**) / security setting (**Windows XP**) after setup of Windows.
- Use standard characters as a computer name: numbers 0 through 9, uppercase and lowercase letters from A to Z, and the hyphen (-) character. If the error message “The computer name is not valid” appears, check if characters other than the above are not entered. If the error message still remains on the display, set the key entry mode to English (“EN”) and enter characters.

Windows 7

- Do not use the following words for user name: CON, PRN, AUX, CLOCK\$, NUL, COM1 to COM9, LPT1 to LPT9, @. In particular, if you create a user name (account name) that includes the "@" mark, a password will be requested at the log-on screen, even if no password has been set. If you try to log on without entering a password, "The user name or password is incorrect." may be displayed and you will not be able to log on to Windows (→ page 30).
- The wallpaper for the first logon user has already been set on "5 Setup Windows."

When using this computer under the Sun, the screen becomes easily viewable by changing the wallpaper to the white wallpaper.

- ① Right-click on the desktop, and click [Personalize] - [Desktop Background].
- ② Select [Solid Colors] at [Picture Location].
- ③ Select the white wallpaper and click [Save changes].

<For MUI OS model>

- When setting up the keyboard, choose the appropriate one to your computer. Otherwise, input by the keyboard may become unavailable.

Windows XP

- You cannot choose the following words for user name and password: CON, PRN, AUX, CLOCK\$, NUL, COM1 to COM9, LPT1 to LPT9.
- When you set date/time/time zone and click [Next], the screen may not go to the next step for a few minutes. Do not touch the keyboard or touch pad, and wait until the screen changes.
- If "An unexpected error has occurred ..." (or a similar message) is displayed, click [OK]. This is not a malfunction.
- Wait until the hard disk drive indicator  has turned off.

<For MUI OS model>

- The keyboard will operate as the US keyboard until the keyboard setting is changed. Because of this, some alphabets shown on display may differ from inputted ones.
To avoid the accidental selections, during setting up Windows,
 - Use the external mouse to make some selections.
 - To match the languages, change the language settings after setting up Windows (→ page 17). Do not change the settings in [To change system or these settings, click Customize] of [Regional and Language Options] during setting up Windows.
-

6 <For MUI OS model> Change the language settings.

<Languages installed in this computer>

| | | | |
|-------------------------|--------------------------|-------------|------------------------|
| • English | • Arabic | • Bulgarian | • Chinese (Simplified) |
| • Chinese (Traditional) | | • Croatian | • Czech |
| • Danish | • Dutch | • Estonian | • Finnish |
| • French | • German | • Greek | • Hebrew |
| • Hungarian | • Italian | • Japanese | • Korean |
| • Latvian | • Lithuanian | • Norwegian | • Polish |
| • Portuguese | • Portuguese (Brazilian) | | • Romanian |
| • Russian | • Slovak | • Slovenian | • Spanish |
| • Swedish | • Thai | • Turkish | |

Change the language settings in the following menu.

[start] - [Control Panel] - [Date, Time, Language, and Regional Options] - [Regional and Language Options]

- [Regional Options] - [Standards and Formats]
- [Languages] - [Language used in menus and dialogs]
- [Languages] - [Details] - [Default input language]
- [Advanced] - [Language for non-unicode Programs]

NOTE

- When you use MUI OS and localized OS versions together on the same network, use English computer names on localized versions of Windows.
- Some UI (User Interface) strings remain in English even if the user's UI is set to another language.
- For more information, refer to "c:\windows\mui\relnotes.txt".
If you change the language in [Languages] - [Language used in menus and dialogs], the desktop color will be changed when logging on to Windows next time. The desktop color can be changed by following the procedure below.
Click [start] - [Control Panel] - [Appearance and Themes] - [Display] - [Desktop] and select color from [Color], then click [OK].

7 Perform the touchscreen calibration.

- To calibrate the touchscreen, use the stylus.

Windows 7

- Before performing the calibration, close Tablet PC Input Panel.

NOTE

- At first, log on to Windows as an administrator and perform this calibration.

① Open the Dashboard for Panasonic PC, and click [Change Settings] in [Touch Calibration].

Alternatively, proceed with the following operation.

Click  (Start) - [Control Panel] - [Hardware and Sound] - [Tablet PC Setting].

② Click [Calibrate].

③ Using the stylus, touch each of the "+" target marks one by one, and then click [Yes].

④ Click [OK].

NOTE

- After completing the calibration as an administrator, perform the calibration for each user by the above steps.
Perform the calibration for the orientation to be used.

Windows XP

- ① Open the Dashboard for Panasonic PC, and click [Change Settings] in [Touch Calibration].
Alternatively, proceed with the following operation.
Click [start] - [All Programs] - [Fujitsu Touch Panel (USB)] - [Touch Screen Calibration Utility].
- ② Using the stylus, touch each of the “+” target marks one by one until it blinks.

Windows XP

8 Create a new account.

Click [start] - [Control Panel] - [User Accounts] - [Create a new account].
Follow the on-screen instructions to create an account.

CAUTION

- Remember your password. If you forget the password, you cannot use the Windows operating system. Creating a password reset disk beforehand is recommended.

NOTE

● PC Information Viewer

This computer periodically records the management information of the hard disk, etc. The maximum data volume for each record is 1024 bytes. This information is only used for estimating the cause in the case when the hard disk goes down by any possibility. They are never sent to outside via network nor used for any other purpose except for the purpose described the above.

To disable the function, add the check mark for [Disable the automatic save function for management information history] in [Hard Disk Status] of PC Information Viewer, and click [OK].

(→  Reference Manual “Checking the Computer’s Usage Status”)

■ When Starting Up/Shutting Down

- Do not do the following
 - Connecting or disconnecting the AC adaptor
 - Pressing the power switch
 - Touching the touchscreen, external mouse or external keyboard
 - Turn on/off the wireless switch

NOTE

- To conserve power, the following power saving methods are set at the time of purchase.
 - The screen automatically turns off after 10^{*1} minutes of inactivity.
 - The computer automatically enters sleep^{*2} (**Windows 7**)/standby^{*2} (**Windows XP**) after 20 minutes of inactivity.

*1 Windows XP :15 minutes

*2 Refer to  Reference Manual “Sleep and Hibernation Functions” about resuming from sleep.

■ When Logging on to Windows

Do not log on to Windows by the Guest account.

Windows 7

■ To change the partition structure

You can shrink a part of an existing partition to create unallocated disk space, from which you can create a new partition. This computer has a single partition as default setting.

- ① Click  (Start) and right-click [Computer], then click [Manage].
 - A standard user needs to enter an administrator password.
- ② Click [Disk Management].
- ③ Right-click the partition for Windows (“c” drive in the default setting), and click [Shrink Volume].
 - The partition size depends on the computer specifications.
- ④ Input the size in [Enter the amount of space to shrink in MB] and click [Shrink].
 - You cannot input a larger number than the displayed size.
 - To select [Reinstall to the first 3 partitions.] in reinstalling Windows 7 (→ page 27), 30000 MB^{*3} or more is necessary for [Total size after shrink in MB].
- ⑤ Right-click [Unallocated] (the shrunk space in the step ④) and click [New Simple Volume].
- ⑥ Follow the on-screen instructions to make the settings, and click [Finish].
Wait until formatting is completed.

^{*3} For MUI OS model, 60000 MB or more is necessary.

NOTE

- You can create an additional partition using remaining unallocated space or newly creating unallocated space.
- To delete a partition, right-click the partition and click [Delete Volume] in step ③.

On-screen Manual

You can access the following manuals on the computer screen.

■ Reference Manual

The Reference Manual contains the practical information to help you fully enjoy the computer's performance.

To access the Reference Manual:

Windows 7 Double-click  on the desktop.

- Alternatively click  (Start) - [All Programs] - [Panasonic] - [On-Line Manuals] - [Reference Manual].

Windows XP Click [start] - [Reference Manual].

- Alternatively click [start] - [All Programs] - [Panasonic] - [On-Line Manuals] - [Reference Manual].

To display "Battery Power" of the Reference Manual, proceed as follows.

Windows 7 Double-click  on the desktop.

- Alternatively click  (Start) - [All Programs] - [Panasonic] - [On-Line Manuals] - [Important Tips].

Windows XP Double-click  on the desktop.

- Alternatively click [start] - [All Programs] - [Panasonic] - [On-Line Manuals] - [Important Tips].

NOTE

- When you access the document of PDF format for the first time, the License Agreement of the Adobe Reader may be displayed. Read it carefully and select [Accept] to proceed.
 - When Adobe Reader update notice is displayed, we recommend you follow the on-screen procedure and update. See <http://www.adobe.com/> for the latest version of Adobe Reader.
-

Handling and Maintenance

Operation environment

- Place the computer on a flat stable surface. Do not place the computer upright or turn it over. If the computer is exposed to an extremely strong impact, it may become damaged.
- Temperature: Operation : -10 °C to 50 °C (IEC60068-2-1, 2)^{*1}
Storage : -20 °C to 60 °C
- Humidity: Operation : 30 % to 80 % RH (No condensation)
Storage : 30 % to 90 % RH (No condensation)

Even within the above temperature/humidity ranges, using for a long time in an extreme environment will result in the product deterioration and will shorten the product life.

- ^{*1} Do not expose the skin to this product when using the product in a hot or cold environment. (→ page 9)
If the computer is wet in temperatures of 0 °C or below, freeze damage may occur. Make sure to dry off the computer in such temperatures.
- Do not place the computer in the following areas, otherwise the computer may be damaged.
 - Near electronic equipment. Image distortion or noise may occur.
 - In extremely high or low temperature.
 - As the computer can become hot during operation, keep it away from items that are sensitive to heat.

Handling cautions

This computer is designed to minimize shock to parts such as the LCD and the hard disk drive, but no warranty is provided against any trouble caused by shock. Be extremely careful when handling the computer.

- When carrying the computer:
 - Turn off the computer.
 - Remove all external devices, cables, Express Cards and other protruding objects.
 - Do not drop or hit the computer against solid objects.
 - Do not grip the display part.
- When you board an airplane, take the computer with you and never put it in your checked luggage. When using the computer on airplane, follow the airline's instructions.
- When carrying a spare battery, put it in a plastic bag to protect its terminals.
- Use only the included stylus to touch the touchscreen. Do not place any object on its surface and do not press down strongly with sharp-pointed or hard objects that may leave marks (e.g., nails, pencils and ball point pens).
- Do not use the touchscreen when dust or dirt (e.g., oil) is on the screen. Otherwise foreign particles on the screen/stylus can scratch the screen surface or obstruct the stylus operation.
- Use the stylus only for touching the screen. Using it for any other purpose may damage the stylus and result in scratches on the screen.

■ When using peripheral devices

Follow these instructions and the Reference Manual to avoid any damage to the devices. Carefully read the instruction manuals of the peripheral devices.

- Use the peripheral devices conforming to the computer's specifications.
- Connect to the connectors in the correct direction.
- If it is hard to insert, do not try forcibly but check the connector's shape, direction, alignment of pins, etc.
- If screws are included, fasten them securely.
- Remove the cables when you carry the computer. Do not pull the cables forcibly.

■ Preventing your computer from unauthorized use via wireless LAN/Bluetooth/wireless WAN

<Only for model with wireless LAN/Bluetooth/wireless WAN>

- Before using wireless LAN/Bluetooth/wireless WAN, make the appropriate security settings such as data encryption.

■ Battery Recalibration

- The battery recalibration may take a long time due to the large battery capacity. This is not a malfunction.
 - Full charge: Approximately 2.0 hours (Normal Temperature Mode)
Approximately 3.5 hours (High Temperature Mode)
 - Complete discharge: Approximately 2.0 hours (Normal Temperature Mode)
Approximately 1.5 hours (High Temperature Mode)

Handling and Maintenance

■ PC-Diagnostic Utility

When you start the PC-Diagnostic Utility without connecting an external keyboard and an external mouse, shut down the computer by pressing and holding the power switch. Then, connect an external keyboard and an external mouse to the computer and restart the PC-Diagnostic Utility.

Maintenance

To clean the LCD panel

Use the soft cloth included with the computer. (For further information, refer to “Suggestions About Cleaning the LCD Surface”. →  *Reference Manual* “Touchscreen”)

To clean areas other than the LCD panel

Wipe with a soft dry cloth such as gauze. When using detergent, dip a soft cloth in water-diluted detergent and wring it thoroughly.

CAUTION

- Do not use benzene, thinner, or rubbing alcohol since it may adversely affect the surface causing discoloration, etc. Do not use commercially-available household cleaners and cosmetics, as they may contain components harmful to the surface.
- Do not apply water or detergent directly to the computer, since liquid may enter inside of the computer and cause malfunction or damage.

Reinstalling Software

Reinstalling software will return the computer to the default condition. When you reinstall the software, the hard disk data will be erased.

Back up important data to other media or an external hard disk before reinstallation.

■ Hard Disk Recovery

The Hard Disk Recovery is not available for some models.

CAUTION

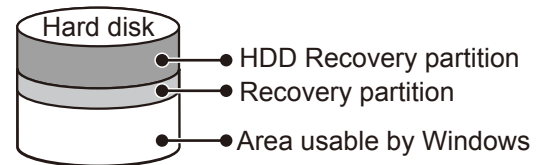

- You can install Windows 7 only.
- Do not delete the recovery partition on the hard disk.
The disk space in the partition is not available to store data.



NOTE

- You can operate with the Tablet Buttons. Follow the instructions displayed on the screen.
You can also use the external keyboard and external mouse.

Preparation

- Remove all peripherals.
 - Connect the AC adaptor and do not remove it until reinstallation is complete.
- 1 Turn on the computer, and click [Click for Enter Setup] on the screen while [Panasonic] boot screen is displayed.**
The Setup Utility starts up.
If the [Panasonic] boot screen is not displayed, as soon as the computer starts up, press  several times until the Setup Utility screen appears.
 - If the password is requested, enter the Supervisor Password.
 - 2 Write down all of the contents of the Setup Utility and click F9.**
At the confirmation message, select [Yes] and click Enter.
 - 3 Click F10.**
At the confirmation message, select [Yes] and click Enter.
Computer will restart.
 - 4 Click [Click for Enter Setup] on the screen while [Panasonic] boot screen is displayed.**
The Setup Utility starts up.
If the [Panasonic] boot screen is not displayed, as soon as the computer starts up, press  several times until the Setup Utility screen appears.
 - If the password is requested, enter the Supervisor Password.
 - 5 Select the [Exit] menu, then select [Repair Your Computer] and click Enter.**
 - 6 Click [Reinstall Windows] and click [Next].**
The License Agreement screen appears.
 - 7 Click [Yes, I agree to the provisions above and wish to continue!] and click [Next].**
 - 8 Select the settings and click [Next].**
 - [Reinstall Windows to the whole Hard Disk to factory default.]
Select this option when you want to reinstall Windows to the factory default. After reinstallation, you can create a new partition. For how to create a new partition, refer to “To change the partition structure” (→ page 21).
 - [Reinstall to the System and OS partitions.]¹
Select this option when the hard disk has already been divided into several partitions. For how to create a new partition, refer to “To change the partition structure” (→ page 21).
You can keep the partition structure.
¹ This does not appear if Windows cannot be reinstalled to the partition containing boot files and the area usable by Windows.
 - 9 At the confirmation message, click [YES].**
 - 10 <For model with localized OS>**
Select OS (32bit or 64bit) and click [OK].
<For model with MUI OS>
Select language and OS (32bit or 64bit), then click [OK].

Reinstalling Software

- 11 At the confirmation message, click [OK].**

Reinstallation starts according to the instructions on the screen.

 - Do not interrupt reinstallation, for example by turning off the computer. Otherwise reinstallation may become unavailable as Windows may not start up or the data may be corrupted.
- 12 When termination screen is displayed, click [OK] to turn off the computer.**
- 13 Turn on the computer.**
 - If the password is requested, enter the Supervisor Password.
- 14 Perform the “First-time Operation” (→ page 17).**
- 15 Start the Setup Utility and change the settings as necessary.**
- 16 Perform Windows Update.**

■ Using Product Recovery DVD-ROM <Only for model with Product Recovery DVD-ROM>

Use the Product Recovery DVD-ROM for reinstallation in the following conditions.

- You have forgotten the administrator password.
- Reinstallation is not complete. The recovery partition may be broken.

NOTE

- When you reinstall OS using the Product Recovery DVD-ROM, OS which was installed as the factory default will be installed. To change OS from 32-bit to 64-bit, or vice versa, reinstall OS using the recovery partition in the hard disk.
- You can operate with the Tablet Buttons. Follow the instructions displayed on the screen. You can also use the external keyboard and external mouse.

Preparation

- Prepare the Product Recovery DVD-ROM
 - Prepare the following items:
 - USB DVD drive (refer to recent catalogs and other sources for information about the products available)
 - Remove all peripherals (excluding USB DVD drive)
 - Connect the AC adaptor and do not remove it until reinstallation is complete.
- 1 Turn off the computer and connect the DVD drive to the USB port.**
 - 2 Turn on the computer, and click [Click for Enter Setup] on the screen while [Panasonic] boot screen is displayed.**

The Setup Utility starts up.

If the [Panasonic] boot screen is not displayed, as soon as the computer starts up, press  several times until the Setup Utility screen appears.

 - If the password is requested, enter the Supervisor Password.
 - 3 Write down all of the contents of the Setup Utility and click F9.**

At the confirmation message, select [Yes] and click Enter.
 - 4 Click F10.**

At the confirmation message, select [Yes] and click Enter.

Computer will restart.
 - 5 Click [Click for Enter Setup] on the screen while [Panasonic] boot screen is displayed.**

The Setup Utility starts up.

If the [Panasonic] boot screen is not displayed, as soon as the computer starts up, press  several times until the Setup Utility screen appears.

 - If the password is requested, enter the Supervisor Password.
 - 6 Set the Product Recovery DVD-ROM into the DVD drive.**
 - 7 Select the [Exit] menu, then select your DVD drive in [Boot Override].**
 - 8 Click Enter.**

The computer will restart.
 - 9 Click [Reinstall Windows] and click [Next].**

The License Agreement screen appears.
 - 10 Click [Yes, I agree to the provisions above and wish to continue!] and click [Next].**

11 Select the settings and click [Next].

- [Reinstall Windows to the whole Hard Disk to factory default.]
Select this option when you want to reinstall Windows to the factory default. After reinstallation, you can create a new partition. For how to create a new partition, refer to “To change the partition structure” (→ page 21).
- [Reinstall to the first 3 partitions.]²
Select this option when the hard disk has already been divided into several partitions. For how to create a new partition, refer to “To change the partition structure” (→ page 21).
You can keep the partition structure.

² This does not appear if Windows cannot be reinstalled to the partition containing boot files and the area usable by Windows.

12 At the confirmation message, click [YES].

Reinstallation starts. (It will take approximately 90 minutes.)

According to the screen, replace the Product Recovery DVD-ROM.

- Do not interrupt reinstallation, for example by turning off the computer. Otherwise reinstallation may become unavailable as Windows may not start up or the data may be corrupted.

13 When termination screen is displayed, remove the Product Recovery DVD-ROM, and then click [OK] to turn off the computer.

14 Remove the DVD drive.

15 Turn on the computer.

- If the password is requested, enter the Supervisor Password.

16 Perform the “First-time Operation” (→ page 17).

17 Start the Setup Utility and change the settings as necessary.

18 Perform Windows Update.







Troubleshooting (Basic)

Follow the instructions below when a problem has occurred. There is also an advanced troubleshooting guide in the "Reference Manual". For a software problem, refer to the software's instruction manual. If the problem persists, contact Panasonic Technical Support. You can also check the computer's status in the PC Information Viewer (→  *Reference Manual* "Checking the Computer's Usage Status").

■ Starting Up

| | |
|--|---|
| <p>Cannot start up. The power indicator or battery indicator is not lit.</p> | <ul style="list-style-type: none"> ● Connect the AC adaptor. ● Insert a fully charged battery. ● Remove the battery pack and the AC adaptor, then connect them again. ● Even if the AC adaptor and battery pack are correctly connected, if the battery indicator is not lit, the AC adaptor protection function may be operating. Disconnect the AC cord, wait three minutes or more, and reconnect the AC cord. ● If a device is connected to the USB port, disconnect the device, or set [USB Port] or [Legacy USB Support] to [Disabled] in the [Advanced] menu of the Setup Utility. ● If a device is connected to the ExpressCard slot, disconnect the device, or set [ExpressCard Slot] to [Disabled] in the [Advanced] menu of the Setup Utility. |
| <p>The power is turned on but "Warming up the system (up to 30 minutes)" appears.</p> | <ul style="list-style-type: none"> ● The computer is warming up before start up. Wait for the computer to start up (takes up to 30 minutes). If, "Cannot warm up the system" is displayed, the computer failed to warm up and does not start. In this case, turn off the computer, leave it in an environment of 5 °C or higher temperature for about an hour, and then turn on the power once more. |
| <p>Cannot turn on the computer. The computer does not resume from sleep (Windows 7)/standby (Windows XP). (The power indicator blinks quickly in green.)</p> | <ul style="list-style-type: none"> ● Leave it in an environment of 5 °C or higher temperature for about an hour, then turn on the power once more. |
| <p>After adding or changing the RAM module, the power is turned on but nothing is displayed on the screen.</p> | <ul style="list-style-type: none"> ● Turn off the computer and remove the RAM module, then confirm whether the RAM module has conformed to specification. When the RAM module has conformed to specification, install it again. |
| <p>Windows 7 The computer does not enter sleep mode while the screen saver is running (The screen stays black).</p> | <ul style="list-style-type: none"> ● Press and hold the power switch for four seconds or longer to shut down the computer forcibly. (Data not saved will be lost.) Then disable the screen saver. |
| <p>It takes time for the power indicator to light up.</p> | <ul style="list-style-type: none"> ● If the power switch is pressed immediately after the battery pack has been mounted on the computer, and while the AC adaptor is not connected, it may take about five seconds before the power indicator lights up and the computer turns on. This is because the computer is checking the remaining battery charge; it is not a malfunction. |
| <p>You have forgotten the password.</p> | <ul style="list-style-type: none"> ● Supervisor Password or User Password: Contact Panasonic Technical Support. ● Administrator password: <ul style="list-style-type: none"> • If you have a password reset disk, you can reset the administrator password. Set the disk and enter any wrong password, then follow the on-screen instructions and set a new password. • If you do not have a password reset disk, reinstall (→ page 25) and set up Windows, and then set a new password. |
| <p>"Remove disks or other media. Press any key to restart" or a similar message appears.</p> | <ul style="list-style-type: none"> ● A floppy disk in the drive or USB memory is connected, and it does not contain system startup information. Remove the floppy disk and USB memory, connect an external keyboard and then press any key. ● If a device is connected to the USB port, disconnect the device, or set [USB Port] or [Legacy USB Support] to [Disabled] in the [Advanced] menu of the Setup Utility. ● If a device is connected to the ExpressCard slot, disconnect the device, or set [ExpressCard Slot] to [Disabled] in the [Advanced] menu of the Setup Utility. ● <Only for model with ExpressCard slot> If the problem persists after removing the disk, it may be a hard disk failure. Contact Panasonic Technical Support. |

■ Starting Up

| | |
|---|---|
| <p>Windows startup and operation is slow.</p> | <ul style="list-style-type: none"> ● Click F9 in the Setup Utility (→  <i>Reference Manual</i> “Setup Utility”) to return the Setup Utility settings (excluding the passwords) to the default values. Start the Setup Utility and make the settings again. (Note that the processing speed depends on the application software, so this procedure may not make Windows faster.) ● If you installed a resident software after purchase, turn off the residence. ● Windows XP Disable Indexing Service in the following menu. Click [start] - [Search] - [Change preferences] - [With Indexing Service (for faster local searches)]. |
| <p>The date and time are incorrect</p> | <ul style="list-style-type: none"> ● Make the correct settings. <ul style="list-style-type: none"> Windows 7 Click  (Start) - [Control Panel] - [Clock, Language, and Region] - [Date and Time]. Windows XP Click [start] - [Control Panel] - [Date, Time, Language, and Regional Options] - [Date and Time]. ● If the problem persists, the internal clock battery may need to be replaced. Contact Panasonic Technical Support. ● When the computer is connected to LAN, check the date and time of the server. ● The 2100 A.D. or later year will not be correctly recognized on this computer. |
| <p>[Executing Battery Recalibration] screen appears.</p> | <ul style="list-style-type: none"> ● The Battery Recalibration was canceled before Windows was shut down last time. To start up Windows, turn off the computer by the power switch, and then turn on. |
| <p>[Enter Password] does not appear when resuming from sleep (Windows 7)/standby (Windows XP)/ hibernation.</p> | <ul style="list-style-type: none"> ● Select [Enabled] in [Password On Resume] in the [Security] menu of the Setup Utility (→  <i>Reference Manual</i> “Setup Utility”). ● The Windows password can be used instead of the password set in the Setup Utility. <ul style="list-style-type: none"> Windows 7 <ol style="list-style-type: none"> ① Click  (Start) - [Control Panel] - [User Accounts and Family Safety] - [Add or remove user accounts] and select the account, and set the password. ② Click  (Start) - [Control Panel] - [System and Security] - [Power Options] - [Require a password on wakeup] and add a check mark for [Require a password]. Windows XP <ol style="list-style-type: none"> ① Click [start] - [Control Panel] - [User Accounts] and select the account, and set the password. ② Click [start] - [Control Panel] - [Performance and Maintenance] - [Power Options] - [Advanced] and add a check mark for [Prompt for password when computer resumes from standby]. |
| <p>Cannot resume.</p> | <ul style="list-style-type: none"> ● An error may occur when the computer automatically enters the sleep (Windows 7) / standby (Windows XP) or hibernation mode while the screen saver is active. In this case, turn off the screen saver or change the pattern of the screen saver. |
| <p>Other startup problems.</p> | <ul style="list-style-type: none"> ● Click F9 in the Setup Utility (→  <i>Reference Manual</i> “Setup Utility”) to return the Setup Utility settings (excluding the passwords) to the default values. Start the Setup Utility and make the settings again. ● Remove all peripheral devices. ● Check to see if there was a disk error. <ul style="list-style-type: none"> Windows 7 <ol style="list-style-type: none"> ① Remove all peripheral devices including an external display. ② Click  (Start) - [Computer] and right-click [Local Disk (C:)], and click [Properties]. ③ Click [Tools] - [Check Now...]. <ul style="list-style-type: none"> • A standard user needs to enter an administrator password. ④ Select the option in [Check disk options] and click [Start]. ⑤ Click [Schedule disk check] and restart the computer. Windows XP <ol style="list-style-type: none"> ① Click [start] - [My Computer] and right-click [Local Disk(C:)], and click [Properties]. ② Click [Tools] - [Check Now]. ③ Select the option in [Check disk options] and click [Start]. ● Connect the external keyboard to the computer, and start it in Safe Mode and check the error details. When the [Panasonic] boot screen disappears^{*1} at startup, press and hold F8 until the Windows Advanced Options Menu is displayed. Select the Safe Mode and press Enter. <p>^{*1} When [Password on boot] is set to [Enabled] or [Auto] in the [Security] menu of the Setup Utility, [Enter Password] appears after the [Panasonic] boot screen disappears. As soon as you enter the password and press Enter, press and hold F8.</p> |

Troubleshooting (Basic)

■ Entering Password

| | |
|---|--|
| <p>Windows 7 Cannot log on to Windows. ("The user name or password is incorrect." is displayed.)</p> | <ul style="list-style-type: none"> ● The user name (account name) includes an "@" mark. <ul style="list-style-type: none"> - If another user account exists: Log on to Windows using another user account, and delete the account that includes "@". Then create a new account. - If no other account exists: You need to reinstall Windows (→ page 25). |
|---|--|

■ Shutting down

| | |
|-----------------------------|---|
| Windows does not shut down. | <ul style="list-style-type: none"> ● Remove the USB device and the ExpressCard. ● Wait one or two minutes. It is not a malfunction. |
|-----------------------------|---|







■ Display

| | |
|---|---|
| No display. | <ul style="list-style-type: none"> ● <Only for model with VGA port> The external display is selected. Change the display output destination. ● <Only for model with VGA port> When using an external display, <ul style="list-style-type: none"> • Check the cable connection. • Turn on the display. • Check the settings of external display. ● The display is turned off by the power-saving function. To resume, touch the screen. ● The computer entered sleep (Windows 7) / standby (Windows XP) or hibernation by the power-saving function. To resume, press the power switch. |
| The screen is dark. | <ul style="list-style-type: none"> ● The screen might be darker when the AC adaptor is not connected. Adjust the brightness by using Dashboard for Panasonic PC. As you increase the brightness, battery consumption increases. You can separately set the brightness for when the AC adaptor is connected and when not connected. |
| The screen is disordered. | <ul style="list-style-type: none"> ● Changing the number of display colors and resolution may affect the screen. Restart the computer. ● Connecting/disconnecting an external display may affect the screen. Restart the computer. ● Resuming from sleep (Windows 7) / standby (Windows XP) or hibernation may affect the screen of the external display. Restart the computer. |
| <Only for model with VGA port> During Simultaneous display, one of the screens becomes disordered. | <ul style="list-style-type: none"> ● When using the Extended Desktop, use the same display colors for the external display as those used by the LCD. If you continue to experience problems, try changing the display. <ul style="list-style-type: none"> Windows 7 <ol style="list-style-type: none"> ① Right-click on the desktop, and click [Graphics Properties]. ② Select [Basic mode] and click [OK]. ③ Click [Display]. Windows XP <ol style="list-style-type: none"> ① Click [start] - [Control Panel] - [Other Control Panel Options] - [Intel(R) Graphics and Media]. ② Select [Basic mode] and click [OK]. ③ Click [Display]. ● Simultaneous display cannot be used until Windows startup is complete (during Setup Utility, etc.). Windows XP <ul style="list-style-type: none"> ● When the [Command Prompt] is set to "Full Screen" by pressing Alt+Enter, the picture is displayed on one of the screens only. When the window display is restored by pressing Alt+Enter on the external keyboard, the picture is displayed on both screens. |
| <Only for model with VGA port> The external display does not work normally. | <ul style="list-style-type: none"> ● If the external display does not support the power saving function, it may not work normally when the computer enters the power saving mode. Turn off the external display. |

■ Display

| | |
|---|--|
| <p>Windows 7 <Only for model with GPS> The cursor cannot be controlled properly.</p> | <ul style="list-style-type: none"> ● Operate the following steps. <ol style="list-style-type: none"> ① Set [GPS] to [Disabled] in the [Advanced] - [Serial Port Setting] of the Setup Utility. ② Click F10 and select [Yes] at the confirmation message, and click Enter (Enter). The computer will restart. ③ Log on to Windows as an administrator. ④ Click  (Start) and input "c:\util\drivers\gps\GPS.reg" in [Search programs and files], and click Enter. ⑤ Click [Yes], click [Yes] and click [OK]. Then restart the computer. ⑥ Click [Click for Enter Setup] that appears at the upper left corner on the screen while [Panasonic] boot screen is displayed. ⑦ Set [GPS] to [Enabled] in the [Advanced] - [Serial Port Setting]. ⑧ Click F10 and select [Yes] at the confirmation message, and click Enter. |
|---|--|

■ Touchscreen



| | |
|---|--|
| <p>The cursor does not work.</p> | <ul style="list-style-type: none"> ● When using the external mouse, connect it correctly. ● Restart the computer using the external keyboard. <p style="margin-left: 20px;">Windows 7 Press  and press  two times, and press  to select [Restart] and press Enter.</p> <p style="margin-left: 20px;">Windows XP Press , , and  to select [Restart].</p> ● If the computer does not respond to the external keyboard commands, read "No response" (→ page 32). |
| <p>Cannot input using the touchscreen.</p> | <p>Windows 7</p> <ul style="list-style-type: none"> ● Set [Touchscreen Mode] to [Auto] or [Tablet Mode] in the [Main] menu of the Setup Utility. <p>Windows XP</p> <ul style="list-style-type: none"> ● Set [Touchscreen Mode] to [Auto] or [Touchscreen Mode] in the [Main] menu of the Setup Utility. |
| <p>Cannot point the correct position using the included stylus.</p> | <ul style="list-style-type: none"> ● Perform the touchscreen calibration (→ page 19). |

■ On-screen Document

| | |
|---|--|
| <p>The document of PDF format is not displayed.</p> | <ul style="list-style-type: none"> ● Install Adobe Reader. <p style="margin-left: 20px;">Windows 7</p> <ol style="list-style-type: none"> ① Click  (Start) and input the following in [Search programs and files], then press Enter. <p style="margin-left: 20px;">Windows XP</p> <ol style="list-style-type: none"> ① Click [start] - [Run], input the following, then click [OK]. <p style="margin-left: 20px;">[c:\util\reader**\Setup.exe]</p> <ul style="list-style-type: none"> ● "**" depends on the language. <ul style="list-style-type: none"> English : m French : f German : g <p style="margin-left: 20px;">If you need Adobe Reader in a language other than above described languages, download from Adobe web site and install it.</p> |
|---|--|

Troubleshooting (Basic)

■ Others

| | |
|--------------|---|
| No response. | <ul style="list-style-type: none">● Windows 7 Press  button to open Task Manager and close the software application that is not responding.● Windows XP Connect the external keyboard and press Ctrl + Shift + ESC to open Task Manager and close the software application that is not responding.● An input screen (e.g., password input screen at startup) may be hidden behind another window. Click Alt+Tab to check.● Press the power switch for 4 seconds or longer to shut down the computer, and then press the power switch to turn it on. If the application program does not work normally, uninstall and reinstall the program. To uninstall,<ul style="list-style-type: none">● Windows 7 click  (Start) - [Control Panel] - [Programs] - [Uninstall a program].● Windows XP click [start] - [Control Panel] - [Add or Remove Programs]. |
|--------------|---|

LIMITED USE LICENSE AGREEMENT

THE SOFTWARE PROGRAM(S) (“PROGRAMS”) FURNISHED WITH THIS PANASONIC PRODUCT (“PRODUCT”) ARE LICENSED ONLY TO THE END-USER (“YOU”), AND MAY BE USED BY YOU ONLY IN ACCORDANCE WITH THE LICENSE TERMS DESCRIBED BELOW. YOUR USE OF THE PROGRAMS SHALL BE CONCLUSIVELY DEEMED TO CONSTITUTE YOUR ACCEPTANCE OF THE TERMS OF THIS LICENSE.

Panasonic Corporation has developed or otherwise obtained the Programs and hereby licenses their use to you. You assume sole responsibility for the selection of the Product (including the associated Programs) to achieve your intended results, and for the installation, use and results obtained therefrom.

LICENSE

- A. Panasonic Corporation hereby grants you a personal, non-transferable and non-exclusive right and license to use the Programs in accordance with the terms and conditions stated in this Agreement. You acknowledge that you are receiving only a LIMITED LICENSE TO USE the Programs and related documentation and that you shall obtain no title, ownership nor any other rights in or to the Programs and related documentation nor in or to the algorithms, concepts, designs and ideas represented by or incorporated in the Programs and related documentation, all of which title, ownership and rights shall remain with Panasonic Corporation or its suppliers.
- B. You may use the Programs only on the single Product which was accompanied by the Programs.
- C. You and your employees and agents are required to protect the confidentiality of the Programs. You may not distribute or otherwise make the Programs or related documentation available to any third party, by time-sharing or otherwise, without the prior written consent of Panasonic Corporation.
- D. You may not copy or reproduce, or permit to be copied or reproduced, the Programs or related documentation for any purpose, except that you may make one (1) copy of the Programs for backup purposes only in support of your use of the Programs on the single Product which was accompanied by the Programs. You shall not modify, or attempt to modify, the Programs.
- E. You may transfer the Programs and license them to another party only in connection with your transfer of the single Product which was accompanied by the Programs to such other party. At the time of such a transfer, you must also transfer all copies, whether in printed or machine readable form, of every Program, and the related documentation, to the same party or destroy any such copies not so transferred.
- F. You may not remove any copyright, trademark or other notice or product identification from the Programs and you must reproduce and include any such notice or product identification on any copy of any Program.

YOU MAY NOT REVERSE ASSEMBLE, REVERSE COMPILE, OR MECHANICALLY OR ELECTRONICALLY TRACE THE PROGRAMS, OR ANY COPY THEREOF, IN WHOLE OR IN PART.

YOU MAY NOT USE, COPY, MODIFY, ALTER, OR TRANSFER THE PROGRAMS OR ANY COPY THEREOF, IN WHOLE OR IN PART, EXCEPT AS EXPRESSLY PROVIDED IN THE LICENSE.

IF YOU TRANSFER POSSESSION OF ANY COPY OF ANY PROGRAM TO ANOTHER PARTY, EXCEPT AS PERMITTED IN PARAGRAPH E ABOVE, YOUR LICENSE IS AUTOMATICALLY TERMINATED.

TERM

This license is effective only for so long as you own or lease the Product, unless earlier terminated. You may terminate this license at any time by destroying, at your expense, the Programs and related documentation together with all copies thereof in any form. This license will also terminate effective immediately upon occurrence of the conditions thereof set forth elsewhere in this Agreement, or if you fail to comply with any term or condition contained herein. Upon any such termination, you agree to destroy, at your expense, the Programs and related documentation together with all copies thereof in any form.

YOU ACKNOWLEDGE THAT YOU HAVE READ THIS AGREEMENT, UNDERSTAND IT AND AGREE TO BE BOUND BY ITS TERMS AND CONDITIONS. YOU FURTHER AGREE THAT IT IS THE COMPLETE AND EXCLUSIVE STATEMENT OF THE AGREEMENT BETWEEN US, WHICH SUPERSEDES ANY PROPOSAL OR PRIOR AGREEMENT, ORAL OR WRITTEN, AND ANY OTHER COMMUNICATIONS BETWEEN US, RELATING TO THE SUBJECT MATTER OF THIS AGREEMENT.

Specifications

This page provides the specifications for the basic model. The model number is different according to the unit configuration.

- To check the model number:
Check the bottom of the computer or the box the computer came in at the time of purchase.
- To check CPU speed, memory size and the hard disk drive (HDD) size:
Run the Setup Utility (→  *Reference Manual* "Setup Utility") and select [Information] menu.
[Processor Speed]: CPU speed, [Memory Size]: Memory size, [Hard Disk]: Hard disk drive size

■ Main Specifications

| Model No. | CF-D1A Series | |
|-----------------------------------|--|--|
| CPU | Intel® Core™ i5-2520M (2.5 GHz, Intel® Smart Cache 3 MB ^{*1}) | |
| Chip Set | Intel® 6 Series Express Chipsets QM67 | |
| Video controller | Built-in Chip Set | |
| Main Memory ^{*2} | 4 GB ^{*1} , DDR3 SDRAM (8 GB ^{*1} Max.) | |
| Video Memory | Windows 7 UMA (<32-bit> 1429 MB ^{*1} Max., <64-bit> 1696 MB ^{*1} Max.) ^{*3} Windows XP UMA (1024 MB ^{*1} Max.) ^{*3} | |
| Hard Disk Drive | 320 GB ^{*4} (Serial ATA) Windows 7 Approx. 40 GB ^{*4} is used as a partition with recovery tools. (Users cannot use this partition.) | |
| Display Method | 13.3 type with Touchscreen (TFT) (1366 × 768 dots) (16:9) | |
| Internal LCD | 65,536/16,777,216 colors (800 × 600 dots / 1024 × 768 dots / 1280 × 600 dots / 1280 × 720 dots / 1280 × 768 dots / 1360 × 768 dots / 1366 × 768 dots) ^{*5} | |
| | 65,536 / 16,777,216 colors (800 × 600 dots / 1024 × 768 dots / 1280 × 768 dots / 1366 × 768 dots / 1600 × 1200 dots / 1920 × 1080 dots / 1920 × 1200 dots) | |
| Touchscreen | Resistive Circular Polarizer | |
| Wireless LAN | Intel® Centrino® Advanced - N 6205 (→ page 35) | |
| Bluetooth ^{*7} | → page 35 | |
| Wireless WAN ^{*8} | Ericsson F5521gw (→ page 36) | |
| LAN | IEEE 802.3 10Base-T / IEEE 802.3u 100BASE-TX / IEEE 802.3ab 1000BASE-T (2nd LAN ^{*9} : IEEE 802.3 10BASE-T, IEEE 802.3u 100BASE-TX) | |
| Sound | WAVE and MIDI playback, Intel® High Definition Audio subsystem support | |
| Security Chip | TPM (TCG V1.2 compliant) ^{*10} | |
| Card Slots | PC Card Slot ^{*11} | × 1, Type I or Type II, Allowable current 3.3 V: 400 mA, 5 V: 400 mA |
| | ExpressCard Slot | × 1, ExpressCard/34 or ExpressCard/54 |
| | SD Memory Card Slot ^{*12} | × 1 |
| | Contact Smart Card Slot ^{*13} | × 1 |
| | SIM Card Slot ^{*8} | × 1 |
| RAM Module Slot | × 2, DDR3 SDRAM, 204-pin, 1.5 V, SO-DIMM, PC3-10600 Compliant | |
| Interface | USB2.0 Ports × 3 or × 4 ^{*14} / Serial Port (Dsub 9-pin male) ^{*15} / LAN Port (RJ-45) × 1 or × 2 ^{*9} / VGA Port (Mini DSub 15-pin female) ^{*16} / Microphone Jack (Miniature jack, 3.5 DIA) / Headphone Jack (Miniature jack, 3.5 DIA, Impedance 32 Ω, Output Power 4 mW × 2, Stereo) / Expansion Bus Connector (Dedicated 100-pin female) / Rugged USB2.0 Port ^{*17} | |
| Pointing Device | Touchscreen | |
| Button | Security, Application × 3, Function | |
| Fingerprint Reader ^{*18} | Array Size : 192 × 4 pixels, Image Size : 192 × 512 pixels, Image Resolution : 508 DPI | |
| Front Camera ^{*19} | Specifications differ depending on the model. | |
| Rear Camera ^{*20} | Specifications differ depending on the model. | |
| Power Supply | AC adaptor or Battery pack | |
| AC Adaptor ^{*21} | Input: 100 V to 240 V AC, 50 Hz/60 Hz, Output: 15.6 V DC, 7.05 A | |

■ Main Specifications

| | | | |
|--|---|-------------|--|
| Model No. | CF-D1A Series | | |
| Battery Pack | Li-ion 10.8 V, Typical 6200 mAh / Minimum 5800 mAh | | |
| Operating Time ^{*22} | Approx. 9.0 hours (Normal Temperature Mode) | | |
| | Approx. 7.0 hours (High Temperature Mode) | | |
| Charging Time ^{*23} | Approx. 2.0 hours (Normal Temperature Mode: in the OFF state) | | |
| | Approx. 2.5 hours (Normal Temperature Mode: in the ON state) | | |
| | Approx. 3.5 hours (High Temperature Mode) | | |
| Power Consumption ^{*24} | Approx. 45 W ^{*25} / Approx. 100 W (maximum when recharging in the ON state) | | |
| Physical Dimensions (W × D × H) (excluding projecting parts) | Approx. 349 mm × 244 mm × 46 mm | | |
| Weight | Approx. 2.25 kg | | |
| Environment | Operating | Temperature | -10 °C to 50 °C (IEC60068-2-1, 2) ^{*26} |
| | | Humidity | 30 % to 80 % RH (No condensation) |
| | Storage | Temperature | -20 °C to 60 °C |
| | | Humidity | 30 % to 90 % RH (No condensation) |

■ Software

| | |
|---------------------------------------|--|
| Base OS | Genuine Windows® 7 Professional |
| Installed OS ^{*27} | Genuine Windows® 7 Professional 32-bit Service Pack 1 / Genuine Windows 7 Professional 64-bit Service Pack 1 |
| Pre-installed Software ^{*27} | Adobe Reader, PC Information Viewer, Loupe Utility, Intel® PROSet/Wireless Software, Bluetooth™ Stack for Windows® by TOSHIBA ^{*7,28} , Wireless Switch Utility, Wireless Connection Disable Utility ^{*29} , Battery Recalibration Utility, Infineon TPM Professional Package ^{*10,29} , Protector Suite QL ^{*18,29} , Aptio Setup Utility, Hard Disk Data Erase Utility ^{*30} , PC Diagnostic Utility, Wireless WAN Connection Manager ^{*8} , Camera Utility ^{*19,20} , Quick Boot Manager, Dashboard for Panasonic PC, Display Rotation Tool, Tablet Button Manager, Hotkey Appendix, Power Plan Extension Utility, Hand Writing, Software Keyboard |

■ Wireless LAN <Only for model with wireless LAN>

| | |
|------------------------|--|
| Data Transfer Rates | IEEE802.11a : 54/48/36/24/18/12/9/6 Mbps (automatically switched) ^{*31} IEEE802.11b : 11/5.5/2/1 Mbps (automatically switched) ^{*31} IEEE802.11g : 54/48/36/24/18/12/9/6 Mbps (automatically switched) ^{*31} IEEE802.11n ^{*32} : (HT20) GI ^{*33} = 400ns: 150/130/115/86/72/65/57/43/28/21/14/7 Mbps (automatically switched) ^{*31} GI ^{*33} = 800ns: 130/117/104/78/65/58/52/39/26/19/13/6 Mbps (automatically switched) ^{*31} (HT40) GI ^{*33} = 400ns: 300/270/240/180/150/135/120/90/60/45/30/15 Mbps (automatically switched) ^{*31} GI ^{*33} = 800ns: 270/243/216/162/135/121/108/81/54/40/27/13 Mbps (automatically switched) ^{*31} |
| Standards Supported | IEEE802.11a / IEEE802.11b / IEEE802.11g / IEEE802.11n |
| Transmission method | OFDM system, DSSS system |
| Wireless Channels Used | IEEE802.11a : Channels 36/40/44/48/52/56/60/64/100/104/108/112/116/120/124/128/132/136/140 ^{*34} IEEE802.11b/IEEE802.11g : Channels 1 to 13 ^{*35} IEEE802.11n : Channels 1-13/36/40/44/48/52/56/60/64/100/104/108/112/116/120/124/128/132/136/140 ^{*36} |
| RF Frequency Band | IEEE802.11a : 5.18 GHz - 5.32 GHz, 5.5 GHz - 5.7 GHz IEEE802.11b/IEEE802.11g : 2.412 GHz - 2.472 GHz IEEE802.11n : 2.412 GHz - 2.472 GHz, 5.18 GHz - 5.32 GHz, 5.5 GHz - 5.7 GHz |

■ Bluetooth™ <Only for model with Bluetooth>

| | |
|------------------------|----------------------------------|
| Bluetooth Version | version 2.1 +EDR (Toshiba Stack) |
| Transmission method | FHSS system |
| Wireless Channels Used | Channel 1 to 79 |
| RF Frequency Band | 2.402 GHz - 2.480 GHz |

Specifications

■ Wireless WAN <Only for model with wireless WAN>

| | | |
|--------------------|---------------------|---|
| Data Communication | HSUPA | Category 6, 5.7 Mbps |
| | HSDPA (HSPA+) | Category 14, 21 Mbps |
| | UMTS | 3GPP Release 7 |
| | EDGE GPRS | MultiSlot Class 10 Circuit Switched Data |
| Other Features | SMS | Mobile Originated SMS (MO-SMS) / Mobile Terminated SMS (MT-SMS) |
| | FAX | No Support |
| | Voice | No Support |
| SIM | 1.8/3 V SIM Support | |

*1 1 MB = 1,048,576 bytes / 1 GB = 1,073,741,824 bytes

*2 Memory size of the factory default depends on the model.

You can physically expand the memory up to 8 GB, but the total amount of usable memory available will be less depending on the actual system configuration.

*3 A segment of the main memory is allotted automatically depending on the computer's operating status. The size of the Video Memory cannot be set by the user. The size of Video memory is allotted depending on the operating system.

*4 1 GB = 1,000,000,000 bytes. Your operating system or some application software will report as fewer GB.

*5 A 16,777,216 color display is achieved by using the dithering function.

*6 Display may be impossible using some connected external displays.

*7 Only for model with Bluetooth.

*8 Only for model with wireless WAN. The specification may differ depending on models.

*9 Only for model with 2nd LAN.

*10 Only for model with TPM.

For information on TPM, refer to the Installation Manual of "TrustedPlatform Module (TPM)" by the following procedure.

Windows 7

Click  (Start) and input "c:\util\drivers\tpm\index.hta" in [Search programs and files] and press **Enter**.

Windows XP

Click [start] - [Run] and input "c:\util\drivers\tpm\index.hta" and click [OK].

*11 Only for model with PC Card slot.

*12 This slot is compatible with High-Speed Mode. Operation has been tested and confirmed using Panasonic SD/SDHC/SDXC Memory Cards with a capacity of up to 64 GB. Operation on other SD equipment is not guaranteed.

*13 Only for model with Smart Card slot.

*14 Only for model with 4th USB2.0 port.

*15 Only for model with serial port.

*16 Only for model with VGA port.

*17 Only for model with rugged USB2.0 port.

*18 Only for model with Fingerprint reader.

*19 Only for model with front camera.

*20 Only for model with rear camera.

*21 <Only for North America>

The AC adaptor is compatible with power sources up to 240 V AC adaptor. This computer is supplied with a 125 V AC compatible AC cord.

20-M-1

*22 Measured with LCD brightness : 60 cd/m²

Varies depending on the usage conditions, or when an optional device is attached.

*23 Varies depending on the usage conditions, CPU speed, etc.

*24 Approx. 0.5 W when the battery pack is fully charged (or not being charged) and the computer is off.

<When using with 115 V AC>

Even when the AC adaptor is not connected to the computer, power is consumed (Max. 0.2 W) simply by having the AC adaptor plugged into an AC outlet.

<When using with 240 V AC>

Even when the AC adaptor is not connected to the computer, power is consumed (Max. 0.3 W) simply by having the AC adaptor plugged into an AC outlet.

*25 Rated power consumption. ^{23-E-1}

*26 Do not expose the skin to this product when using the product in a hot or cold environment. (→ page 9)

When using in hot or cold environment, some peripherals may fail to work properly. Check the operation environment of the peripherals.

Using this product continuously in a hot environment will shorten the product life. Avoid use in these types of environments.

When using in low temperature environment, startup may become slow or battery operation time may become short.

The computer consumes power when the hard disk is warming up during startup. Therefore, if you are using battery power and the remaining power is low, the computer may not start up.

*27 Operations of this computer are not guaranteed except for the pre-installed OS and the OS which is installed by using the Product Recovery DVD-ROM provided by Panasonic.

<Only for model with Product Recovery DVD-ROM>

Some parts of the software in the Product Recovery DVD-ROM may not be installed depending on a model.

*28 May not be installed depending on the model.

*29 Must be installed before use.

*30 Perform on the recovery partition.

*31 These are speeds specified in IEEE802.11a+b+g+n standards. Actual speeds may differ.

*32 Available when set to "WPA-PSK", "WPA2-PSK" or "none".

*33 Only available when HT40 enabled by the computer and access point which associated supports HT40.

^{*34} <Model for U.S.A and Canada>
IEEE802.11a : Channels 36/40/44/48/52/56/60/64/100/104/108/112/116/132/136/140/149/153/157/161/165

^{*35} <Model for U.S.A and Canada>
IEEE802.11b/IEEE802.11g : Channels 1 to 11

^{*36} <Model for U.S.A and Canada>
IEEE802.11n : Channels 1-13/36/40/44/48/52/56/60/64/100/104/108/112/116/132/136/140/149/153/157/161/165



As an ENERGY STAR® Partner, Panasonic Corporation has determined that this product meets ENERGY STAR® guidelines for energy efficiency. By enabling available power management settings, Panasonic computers enter a low-power sleep mode after a period of inactivity, saving the user energy.

<Only for U.S.A.>

To learn more about power management, please visit the web site:

www.energystar.gov/index.cfm?c=power_mgt.pr_power_management

Outline of the International ENERGY STAR® Office Equipment Program

The international ENERGY STAR® Office Equipment Program is an international program that promotes energy saving through the use of computers and other office equipment. The program backs the development and dissemination of products with functions that effectively reduce energy consumption. It is an open system in which business proprietors can participate voluntarily. The targeted products are office equipment such as computers, displays, printers, facsimiles, and copiers. Their standards and logos are uniform among participating nations.

22-E-1

<Only for U.S.A.>

For information about ENERGY STAR®, refer to the following web side:

Web Site: www.energystar.gov

Panasonic Corporation

Panasonic Solutions Company

3 Panasonic Way, Panazip 2F-5, Secaucus, NJ 07094

Panasonic Canada Inc.

5770 Ambler Drive Mississauga, Ontario L4W 2T3

Importer's name & address pursuant to the EU GPSD (General Product Safety Directive) 2001/95/EC Art.5

Panasonic Computer Products Europe, Panasonic Marketing Europe GmbH

Hagenauer Straße 43

65203 Wiesbaden

Germany

55-E-1

Web Site : <http://panasonic.net/>

パナソニック株式会社 ITプロダクツビジネスユニット

〒 570-0021 大阪府守口市八雲東町一丁目 10 番 12 号